

wise up to floorwise
quality & value guaranteed



national distributor network

- 1 Neil Smith Ltd**
Glasgow, G4 0TX
Tel: 0141 552 1141
sales@neilsmithltd.co.uk
- 2 Provincial Floorcoverings Ltd**
Belfast, BT15 3GU
Tel: 028 9075 3202
salesbelfast@pfi.ie
- 3 Provincial Floorcoverings Ltd**
Dublin, D12 E540
Tel: 00353 (0)1 626 3913
salesdublin@pfi.ie
- 4 Provincial Floorcoverings Ltd**
Limerick, V94 Y8D4
Tel: 00353 (0)61 227 100
sales@pfi.ie
- 5 Lakes Flooring Supplies**
Kendal, LA9 5RR
Tel: 01539 726500
sales@pucfloorsupplies.co.uk
- 6 Preston Underlay Centre Ltd**
Preston, PR1 1PN
Tel: 01772 556345
sales@pucfloorsupplies.co.uk
- 7 Birch Distribution**
Leeds, LS10 1AG
Tel: 0113 244 4363
l.sales@birchdistribution.co.uk
- 8 Birch Distribution**
Hull, HU7 0XD
Tel: 01482 826654
h.sales@birchdistribution.co.uk
- 9 Hathaway Flooring**
Manchester, M17 1EB
Tel: 0161 872 8003
sales@hathawayflooring.com
- 10 Cornerstone Flooring**
Doncaster, DN3 3FE
Tel: 01302 835117
Fax: 01302 302542
cornerstonefloor@btconnect.com
- 11 Birch Distribution**
Sheffield, S9 5PH
Tel: 0114 243 1230
s.sales@birchdistribution.co.uk
- 12 Woodall Brothers Ltd**
Shrewsbury, SY1 3JE
Tel: 01743 441584
sales@woodallbrothers.co.uk
- 13 Floorwise D & J Ltd**
Southam, CV47 0DR
Tel: 01926 814922
sales@wdj.co.uk
- 14 BL Flooring Supplies Ltd**
Gloucester, GL2 5HY
Tel: 01452 223355
info@biflooring.co.uk
- 15 BL Flooring Supplies Ltd**
Bristol, BS2 9SH
Tel: 0117 955 5454
info@biflooring.co.uk
- 16 Salesmark West Ltd**
Amesbury, SP4 7LN
Tel: 01980 880933
mail@salesmark-west.co.uk
- 17 Salesmark**
Lancing, BN15 8UN
Tel: 01903 750522
sales@salesmark-floorwise.co.uk
- 18 Fitwell Flooring Ltd**
Newton Abbot, TQ12 6TR
Tel: 01626 835935
sales@fitwell.co.uk
- 19 Fitwell Flooring Ltd**
Redruth, TR15 1SS
Tel: 01209 214344
sales@fitwell.co.uk
- 20 STS Flooring Distributors Ltd**
Cambridge, CB23 8UD
Tel: 0345 899 1000
sales@stsflooring.co.uk
- 21 STS Flooring Distributors Ltd**
Hemel Hempstead, HP2 7ER
Tel: 0345 899 1000
sales@stsflooring.co.uk
- 22 STS Flooring Distributors Ltd**
Basilston, Essex, SS14 3DW
Tel: 0345 899 1000
sales@stsflooring.co.uk
- 23 STS Flooring Distributors Ltd**
Croydon, Surrey, CR0 4WP
Tel: 0345 899 1000
sales@stsflooring.co.uk
- 24 STS Flooring Distributors Ltd**
Orpington, Kent, BR5 3SS
Tel: 0345 899 1000
sales@stsflooring.co.uk
- 25 ProFlooring s.r.o.**
Prague, Bavorská 856/14
Czech Republic
Tel: +420 224 454 231
info@proflooring.cz

head office:

Floorwise Group Ltd.
 Floorwise House, 22 High Street
 Kegworth, Derby
 DE74 2DA, UK
 Tel: +44 (0)1509 673974



Fantastic floors
 start with **floorwise**



- UNDERLAY**
- ADHESIVES & SCREEDS**
- PROFILES**
- GRIPPER**
- TOOLS**
- TAPES**
- NOSINGS & TRIMS**
- MATTING**
- CARPET TILES**



Fantastic floors start with Floorwise

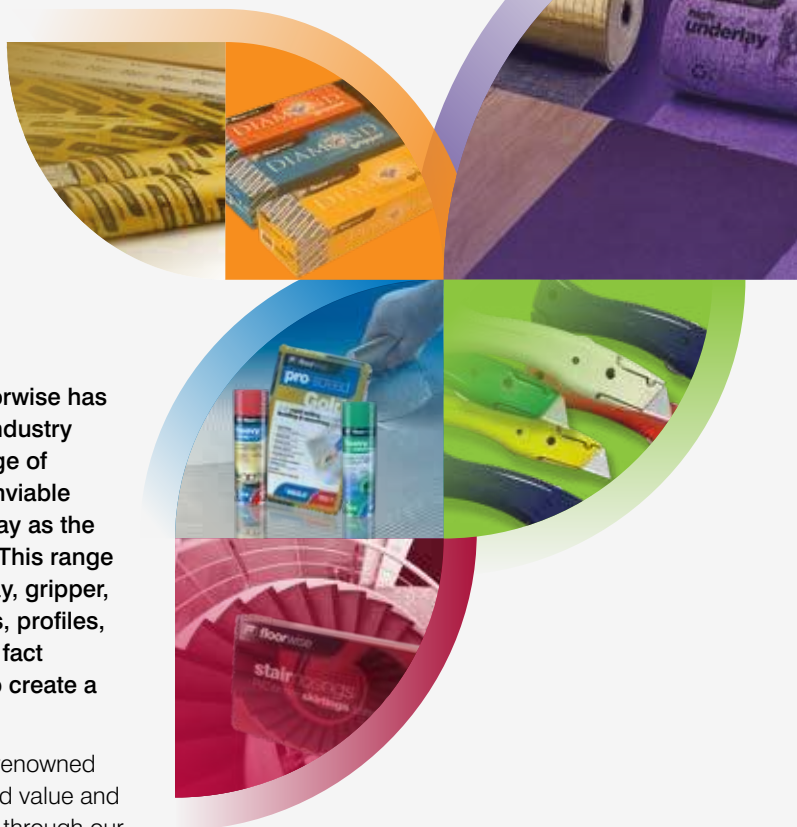

For over 40 years, Floorwise has supplied the flooring industry with an ever wider range of products earning an enviable reputation along the way as the professionals' choice. This range today includes underlay, gripper, adhesives and screeds, profiles, tools and far more – in fact everything you need to create a fantastic floor.

Floorwise products are renowned for combining quality and value and are available exclusively through our network of independent distributors who can help advise customers as to the best option for their requirements with their extensive product knowledge.

This is why fantastic floors start with Floorwise.

This is a Floorwise product guide only. If you have any questions about prices please contact your local Floorwise distributor (see back cover).

Underlays

Feel The Difference	6
PU Foam Underlays	8
Rubber and Felt Underlays	16
Carpet Underlay Selector	20
Wood/Laminate underlays	24
Plywood, Hardboard and Felt	34
Scotia	35

Adhesives and Screeds

Screeds	36
Adhesives	46

Gripper

Premium Gripper	51
Diamond Gripper	51

Profiles

Max Reflections	53
Max Profiles	54
Profile Displays	55
Classic Profiles	56
Zenith Profiles	58
Flexible Floor Profiles	60

Stair Nosings

Aluminium Stair Nosings	63
Q Range	64
Stair Edge Trims and Angles	66
Floormitre Cap and Cove System	66
Bevels, Ramps, Profiles and Joints	67
Skirtings	68
Colour Charts	70

Tools and Sundries

Cutting	73
Carpet Fitting	74
Measuring and Scribing	77
Surface Preparation	79
Wood and Laminate Floor Laying	80
PVC/Lino Laying	81
Workwear and Protection	82
Storage and Handling	82

Floor Coverings

Entrance matting	84
Carpet tiles	86

Tapes

Heatseam Tape	89
Adhesive Tape	89

Artificial Grass

Artificial Grass	91
Accessories	91

Underlay

Carpet Underlays	4
Feel the Difference	6
PU Foam Underlays	8
Carpet Underlay Selector	20

There are a wide range of underlay options available today; each has its own strengths and weaknesses so care should be taken in selecting the most suitable for your project.



PU Foam Underlays The market leader!

Although light in weight, PU foam underlays pack a real punch when it comes to comfort and performance. Being under half the weight of traditional rubber underlays means that they can easily be handled on site in line with current health and safety regulations.

They are made from recycled post-industrial foam which is compressed and re-bonded to create a wide range of thicknesses and densities to suit a variety of applications and budgets.

The use of recycled materials helps to keep costs to a minimum making foam underlays excellent value for money and once they have reached the end of their useful life they are also 100% recyclable making them kinder to the environment – all of which explains their enduring popularity.

Bouncebackability Index

Underlays are a great way to increase the comfort and durability of your flooring - but every underlay material has its own strengths and weaknesses to consider. This is where understanding bouncebackability can help decide what is best for you.

Bouncebackability considers the impact of density on an underlay as an Ultra High Density underlay will typically have over twice the weight of foam as a Medium Density underlay, compressed into the same volume. This increased density gives greater resistance to compression making it feel firmer underfoot. The higher foam densities are therefore ideal for use in more heavily trafficked areas such as halls, lounges and landings, and commercial applications. In contrast, lower density foams are great for lower trafficked areas where you may be barefoot and appreciate a softer feel, such as bedrooms.

The balance of comfort and durability greatly depends upon the flooring type, the place it is to be laid and the footfall expected. Our bouncebackability chart helps to explain how a higher density underlay will initially feel much firmer underfoot but will be more consistent as it better resists the longer-term compression forces generated through footfall. In contrast a lower density underlay will initially feel softer but this will decrease more rapidly as the foam compresses underfoot.

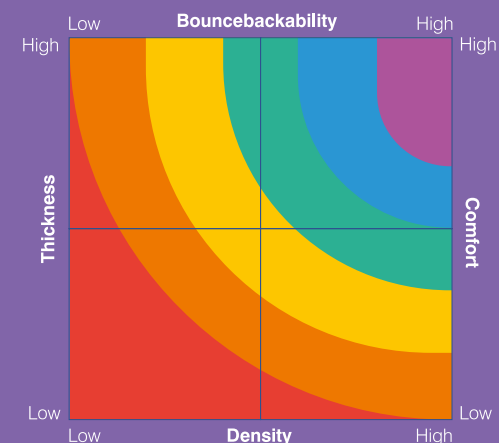

Blown Rubber

Formed under intense heat to create pockets of air, this type of rubber underlay delivers increasingly higher levels of comfort and durability depending upon thickness and density.

Crumb Rubber

Crumb rubber underlays are made using the rubber from recycled car tyres. They have the best durability and recovery ratings of all underlays. Suitable for areas of heavy wear in both residential and commercial installations, for many, these are the ultimate performance underlays, providing the best support for your carpet.

Rubber Underlays

These more traditional underlays deliver an excellent balance of comfort and durability whilst their exceptional density provides excellent acoustic insulation properties.

Wool Felt Underlays

As one of the original carpet underlays, wool felt continues to be the natural choice for your carpet. With exceptional heat insulation properties, wool felt underlays have great bedding down qualities and are extensively used with woven backed carpets. Made from recycled wool, jute and synthetic fibres these underlays are fully recyclable after their long use.

Combination Crumb Rubber/Wool Felt Underlays

These combination underlays provide the exceptional recovery properties of crumb rubber, with the great bedding in and heat insulation properties of wool felt.

Underlay Density

The denser the underlay, the more durable it is and the better it will perform over time. We offer 5 density categories as follows.



Comfort

Comfort underfoot is primarily influenced by underlay thickness (although density also plays a part), with the thickest being the most comfortable. We offer underlays in a range of thicknesses.

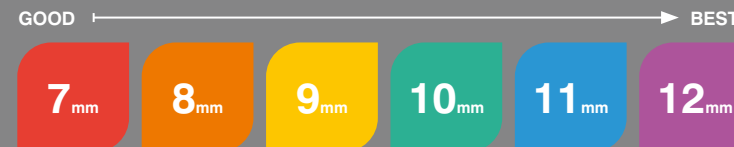

Using premium materials for underlays of exquisite quality. Feel the Difference is a collection that truly delivers comfort and luxury under your feet.

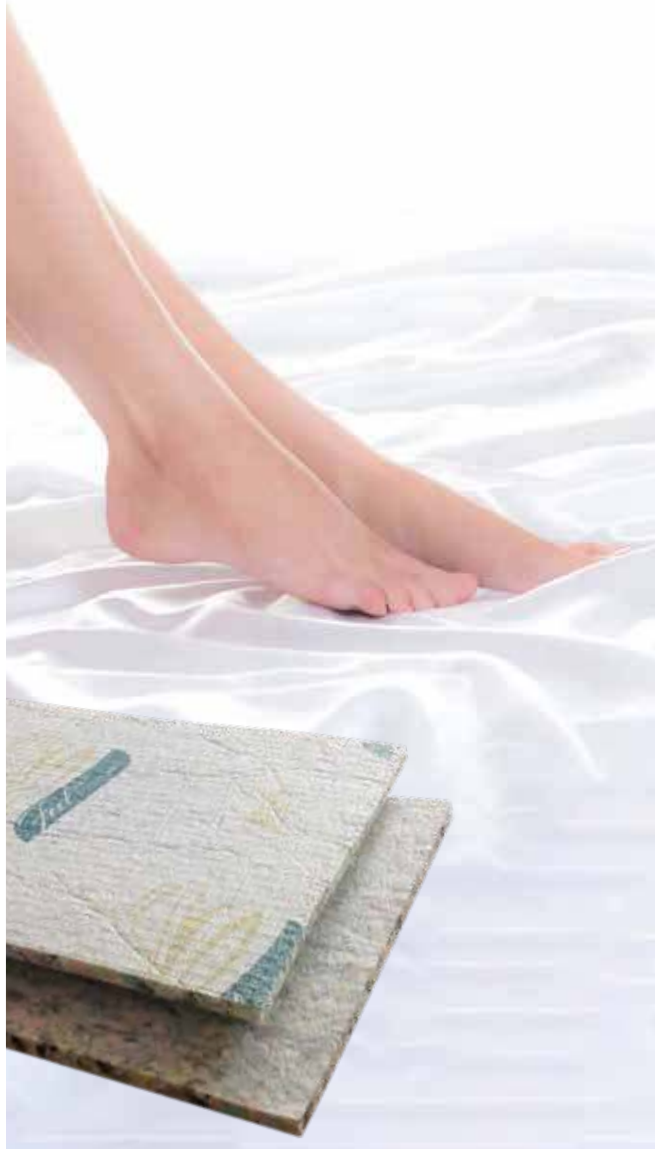

UHG+

Elegance

10mm



High performance recycled PU foam underlay

DIMENSIONS

Roll size 1.37 x 11m
= 15.07m²

APPLICATION

Usage BS 5808 Luxury (L/U)
Traffic Residential or commercial

PERFORMANCE

Comfort ★★★★★
Durability ★★★★★★
Bounceback ★★★★★
Heat Insulation 2.54 TOG
Sound reduction 46dB

Product reference:
F9FTDEL

Inspiration

10mm



High performance sponge rubber waffle underlay

DIMENSIONS

Roll size 1.37 x 8m
= 10.96m²

APPLICATION

Usage BS 5808 Luxury (L/U)
Traffic Residential or commercial

PERFORMANCE

Comfort ★★★★★
Durability ★★★★★★
Bounceback ★★★★★
Heat Insulation 1.71 TOG
Sound reduction 46dB

Product reference:
F9FTDIN

Prestige

11mm



High performance rubber crumb plus felt underlay

DIMENSIONS

Roll size 1.37 x 7.3m
= 10.00m²

APPLICATION

Usage BS 5808 Heavy contract (HC/U)
Traffic Residential or commercial

PERFORMANCE

Comfort ★★★★★
Durability ★★★★★★
Bounceback ★★★★★
Heat Insulation 2.55 TOG
Sound reduction 34dB

Product reference:
F9FTDPR

SH+

Desire

9mm

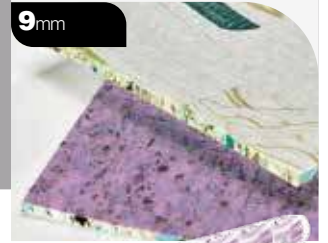

High performance recycled PU foam underlay

DIMENSIONS

Roll size 11 x 1.37m
= 15.07m²

APPLICATION

Usage BS 5808 Luxury (L/U)
Traffic Residential or commercial

PERFORMANCE

Comfort ★★★
Durability ★★★★★★
Bounceback ★★★★★
Heat Insulation 2.28 TOG
Sound reduction 40dB

Product reference:
F9FTDES

For prices contact your nearest distributor – see back cover

PU Foam Underlays

UHD

tread

9mm

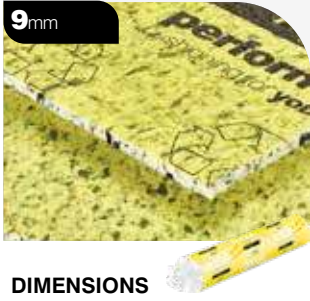

DIMENSIONS

Roll size 1.37 x 11m
= 15.07m²

APPLICATION

Usage BS 5808 Luxury (L/U)
Traffic Residential or commercial

PERFORMANCE

Comfort ★★★
Durability ★★★★★
Bounceback ★★★★★
Heat Insulation 2.41 TOG
Sound reduction 39dB

Mesh grid backing

Product reference:
F9TRE

SHD

lift

7mm

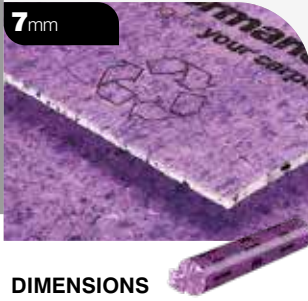

DIMENSIONS

Roll size 1.37 x 11m
= 15.07m²

APPLICATION

Usage BS 5808 Heavy contract (HC/U)
Traffic Residential or commercial

PERFORMANCE

Comfort ★★
Durability ★★★★★
Bounceback ★★★★★
Heat Insulation 2.12 TOG
Sound reduction 37dB

Suitable for wheeled traffic

Product reference:
F9LIF

allure

11mm

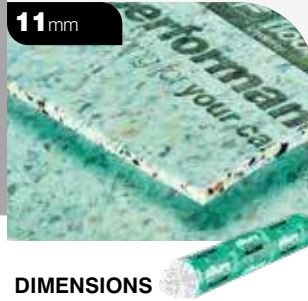

DIMENSIONS

Roll size 1.37 x 11m
= 15.07m²

APPLICATION

Usage BS 5808 Luxury (L/U)
Traffic Residential or commercial

PERFORMANCE

Comfort ★★★★★
Durability ★★★★★
Bounceback ★★★★★
Heat Insulation 2.53 TOG
Sound reduction 46dB

Product reference:
F9AL

supreme

11mm

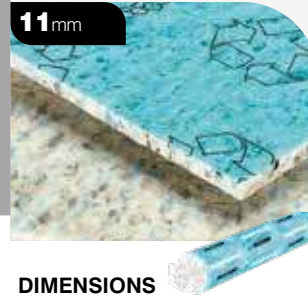

DIMENSIONS

Roll size 1.37 x 11m
= 15.07m²

APPLICATION

Usage BS 5808 Luxury (L/U)
Traffic Residential or commercial

PERFORMANCE

Comfort ★★★★★
Durability ★★★★★
Bounceback ★★★★★
Heat Insulation 2.94 TOG
Sound reduction 43dB

Product reference:
F9SU

esteem

10mm

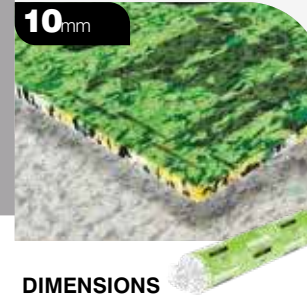

DIMENSIONS

Roll size 1.37 x 11m
= 15.07m²

APPLICATION

Usage BS 5808 Luxury (L/U)
Traffic Residential or commercial

PERFORMANCE

Comfort ★★★★★
Durability ★★★★★
Bounceback ★★★★★
Heat Insulation 2.46 TOG
Sound reduction 45dB

Product reference:
F9ES10

verve

9mm



DIMENSIONS

Roll size 1.37 x 11m
= 15.07m²

APPLICATION

Usage BS 5808 Luxury (L/U)
Traffic Residential or commercial

PERFORMANCE

Comfort ★★★
Durability ★★★★★
Bounceback ★★★★★
Heat Insulation 2.17 TOG
Sound reduction 42dB

Product reference:
F9VE

For prices contact your nearest distributor – see back cover

For prices contact your nearest distributor – see back cover

PU Foam Underlays

SH+

vitality

9mm

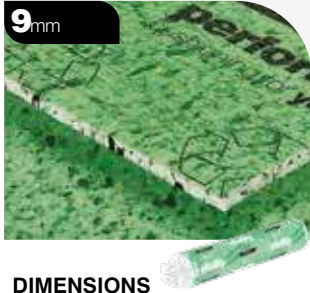

DIMENSIONS

Roll size 1.37 x 11m
= 15.07m²

APPLICATION

Usage BS 5808 Luxury (L/U)
Traffic Residential

PERFORMANCE

Comfort ★★★
Durability ★★★★★
Bounceback ★★★★★
Heat Insulation 2.32 TOG
Sound reduction 39dB

Product reference:
F9VIT

EHD+

flexilay 11

11mm



DIMENSIONS

Roll size 1.37 x 11m
= 15.07m²

APPLICATION

Usage BS 5808 Luxury (L/U)
Traffic Residential

PERFORMANCE

Comfort ★★★★★
Durability ★★★★★
Bounceback ★★★
Heat Insulation 3.64 TOG
Sound reduction 45dB

Product reference:
F9FL11

maxi

11mm



DIMENSIONS

Roll size 1.37 x 11m
= 15.07m²

APPLICATION

Usage BS 5808 Luxury (L/U)
Traffic Residential

PERFORMANCE

Comfort ★★★★★
Durability ★★★★★
Bounceback ★★★
Heat Insulation 3.64 TOG
Sound reduction 45dB

Product reference:
F9MA

flexilay 9

9mm

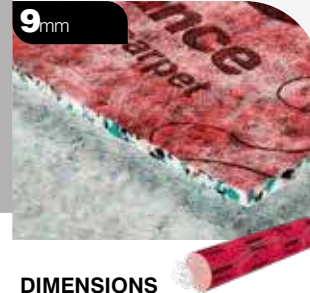

DIMENSIONS

Roll size 1.37 x 11m
= 15.07m²

APPLICATION

Usage BS 5808 Luxury (L/U)
Traffic Residential

PERFORMANCE

Comfort ★★★
Durability ★★★★★
Bounceback ★★★★★
Heat Insulation 2.75 TOG
Sound reduction 41dB

Product reference:
F9FL9

traffic

9mm



DIMENSIONS

Roll size 1.37 x 11m
= 15.07m²

APPLICATION

Usage BS 5808 Luxury (L/U)
Traffic Residential

PERFORMANCE

Comfort ★★★
Durability ★★★★★
Bounceback ★★★★★
Heat Insulation 2.75 TOG
Sound reduction 41dB

Product reference:
F9TRAF

H+

lush

12mm



DIMENSIONS

Roll size 1.37 x 11m
= 15.07m²

APPLICATION

Usage BS 5808 Luxury (L/U)
Traffic Residential

PERFORMANCE

Comfort ★★★★★
Durability ★★★★★
Bounceback ★★
Heat Insulation 3.26 TOG
Sound reduction 45dB

Product reference:
F9LU

PU Foam Underlays

HB+

dash

11mm

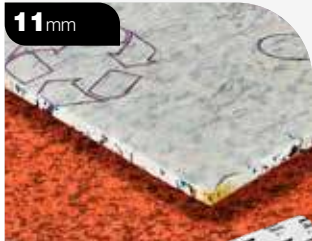

DIMENSIONS

Roll size 1.37 x 11m
= 15.07m²

APPLICATION

Usage BS 5808 Luxury (L/U)
Traffic Residential

PERFORMANCE

Comfort ★★★★★
Durability ★★★
Bounceback ★★★
Heat Insulation 2.85 TOG
Sound reduction 42dB

Product reference:
F9DA

panache

10mm



DIMENSIONS

Roll size 1.37 x 11m
= 15.07m²

APPLICATION

Usage BS 5808 Luxury (L/U)
Traffic Residential

PERFORMANCE

Comfort ★★★★★
Durability ★★★
Bounceback ★★★
Heat Insulation 2.51 TOG
Sound reduction 44dB

Product reference:
F9PA

spirit

10mm

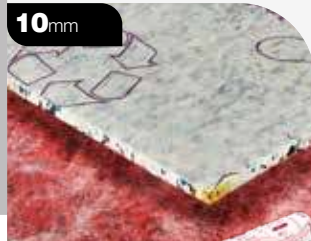

DIMENSIONS

Roll size 1.37 x 11m
= 15.07m²

APPLICATION

Usage BS 5808 Luxury (L/U)
Traffic Residential

PERFORMANCE

Comfort ★★★★★
Durability ★★★
Bounceback ★★★
Heat Insulation 2.51 TOG
Sound reduction 36dB

Product reference:
F9SP

lusso

10mm



DIMENSIONS

Roll size 1.37 x 11m
= 15.07m²

APPLICATION

Usage BS 5808 General (GD/U)
Traffic Residential

PERFORMANCE

Comfort ★★★★★
Durability ★★★
Bounceback ★★
Heat Insulation 2.56 TOG
Sound reduction 38dB

Product reference:
F9LU

bravo

9mm



DIMENSIONS

Roll size 1.37 x 11m
= 15.07m²

APPLICATION

Usage BS 5808 General (GD/U)
Traffic Residential

PERFORMANCE

Comfort ★★★
Durability ★★★
Bounceback ★★★
Heat Insulation 2.22 TOG
Sound reduction 37dB

Product reference:
F9BRE

style

8mm



DIMENSIONS

Roll size 1.37 x 11m
= 15.07m²

APPLICATION

Usage BS 5808 General (GD/U)
Traffic Residential

PERFORMANCE

Comfort ★★★
Durability ★★★
Bounceback ★★★
Heat Insulation 2.23 TOG
Sound reduction 37dB

Product reference:
F9ST

For prices contact your nearest distributor – see back cover

For prices contact your nearest distributor – see back cover

PU Foam Underlays

HB+

solo

8mm



DIMENSIONS

Roll size 1.37 x 11m
= 15.07m²

APPLICATION

Usage BS 5808 General (GD/U)
Traffic Residential

PERFORMANCE

Comfort ★★★
Durability ★★★
Bounceback ★★★
Heat Insulation 2.23 TOG
Sound reduction 37dB

Product reference:
F9SO

MG+

prima

8mm

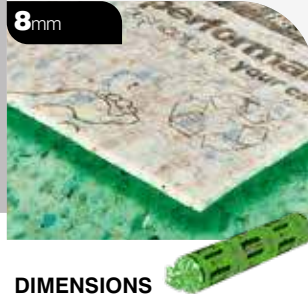

DIMENSIONS

Roll size 1.37 x 11m
= 15.07m²

APPLICATION

Usage BS 5808 Luxury (L/U)
Traffic Residential

PERFORMANCE

Comfort ★★
Durability ★★★
Bounceback ★★★
Heat Insulation 2.01 TOG
Sound reduction 37dB

Product reference:
F9PRE

attivo

10mm

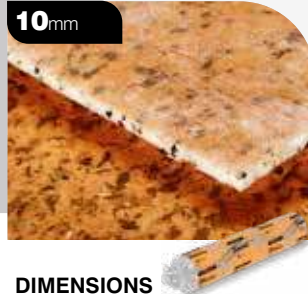

DIMENSIONS

Roll size 1.37 x 11m
= 15.07m²

APPLICATION

Usage BS 5808 General (GD/U)
Traffic Residential

PERFORMANCE

Comfort ★★★★★
Durability ★★
Bounceback ★★
Heat Insulation 2.68 TOG
Sound reduction 41dB

Product reference:
F9AT

essentials 10mm

10mm

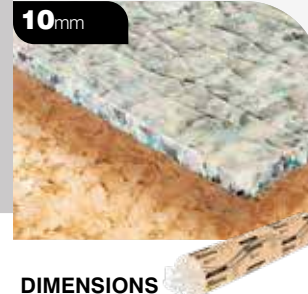

DIMENSIONS

Roll size 1.37 x 11m
= 15.07m²

APPLICATION

Usage BS 5808 General (GD/U)
Traffic Residential

PERFORMANCE

Comfort ★★★★★
Durability ★★
Bounceback ★★
Heat Insulation 2.37TOG
Sound reduction 41dB

Product reference:
F9ES10

senso

8mm

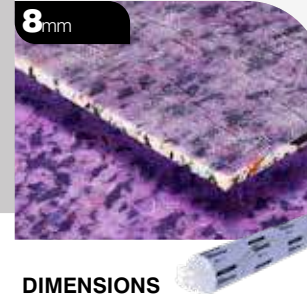

DIMENSIONS

Roll size 1.37 x 11m
= 15.07m²

APPLICATION

Usage BS 5808 General (GD/U)
Traffic Residential

PERFORMANCE

Comfort ★★
Durability ★★
Bounceback ★★
Heat Insulation 2.23 TOG
Sound reduction 36dB

Product reference:
F9SE

essentials 8mm

8mm

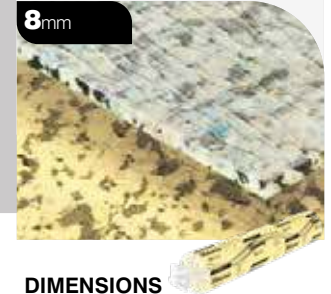

DIMENSIONS

Roll size 1.37 x 11m
= 15.07m²

APPLICATION

Usage BS 5808 General (GD/U)
Traffic Residential

PERFORMANCE

Comfort ★★
Durability ★★
Bounceback ★★
Heat Insulation 1.94 TOG
Sound reduction 36dB

Product reference:
F9ES8E

For prices contact your nearest distributor – see back cover

For prices contact your nearest distributor – see back cover

Rubber and Felt Underlays



champion

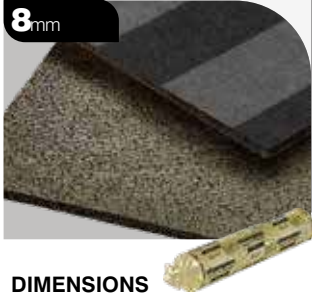

DIMENSIONS
Roll size 1.37 x 8m
 = 10.96m²

APPLICATION
Usage BS 5808 Heavy contract (HC/U)
Traffic Residential or commercial

PERFORMANCE
Comfort ★★★
Durability ★★★★★
Bounceback ★★★★★
Heat Insulation 1.31 TOG
Sound reduction 33dB

Suitable for wheeled traffic

Product reference:
 F9CH

optima



DIMENSIONS
Roll size 1.37 x 8m
 = 10.96m²

APPLICATION
Usage BS 5808 Heavy contract (HC/U)
Traffic Residential or commercial

PERFORMANCE
Comfort ★★★
Durability ★★★★★
Bounceback ★★★★★
Heat Insulation 1.45 TOG
Sound reduction 34dB

Suitable for wheeled traffic

Product reference:
 F9OP

vigour



DIMENSIONS
Roll size 1.37 x 11m
 = 15.07m²

APPLICATION
Usage BS 5808 Heavy contract (HC/U)
Traffic Residential or commercial

PERFORMANCE
Comfort ★★
Durability ★★★★★
Bounceback ★★★★★
Heat Insulation 1.19 TOG
Sound reduction 30dB

Suitable for wheeled traffic

Product reference:
 F9VIG

endura



DIMENSIONS
Roll size 1.37 x 11m
 = 15.07m²

APPLICATION
Usage BS 5808 Heavy contract (HC/U)
Traffic Residential or commercial

PERFORMANCE
Comfort ★★
Durability ★★★★★
Bounceback ★★★★★
Heat Insulation 1.26 TOG
Sound reduction 32dB

Suitable for wheeled traffic

Product reference:
 F9EN

pinnacle

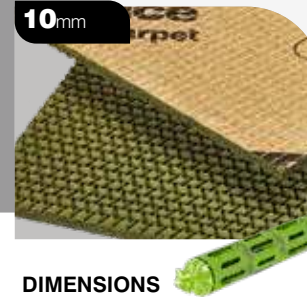

DIMENSIONS
Roll size 1.33 x 8.24m
 = 10.96m²

APPLICATION
Usage BS 5808 Luxury (L/U)
Traffic Residential

PERFORMANCE
Comfort ★★★★★
Durability ★★★★★
Bounceback ★★★★★
Heat Insulation 1.54 TOG
Sound reduction 38dB

Suitable for wheeled traffic

Product reference:
 F9PI

thermaflow impact



DIMENSIONS
Roll size 1.33 x 8.24m
 = 10.96m²

APPLICATION
Usage BS 5808 Heavy contract (HC/U)
Traffic Residential or commercial

PERFORMANCE
Comfort ★★
Durability ★★★★★
Bounceback ★★★★★
Heat Insulation 0.79 TOG
Sound reduction 34dB

Suitable for wheeled traffic

Product reference:
 F9TI

For prices contact your nearest distributor – see back cover

For prices contact your nearest distributor – see back cover

Rubber and Felt Underlays

UHD

duet sovereign

11mm

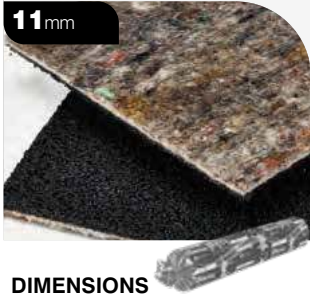

DIMENSIONS

Roll size 1.37 x 7.3m
= 10.00m²

APPLICATION

Usage BS 5808 Heavy contract (HC/U)
Traffic Residential or commercial

PERFORMANCE

Comfort ★★★★★
Durability ★★★★★★
Bounceback ★★★★★★
Heat Insulation 2.95 TOG
Sound reduction 34dB

Suitable for wheeled traffic

Product reference:
F9DSO

duet supreme

10mm

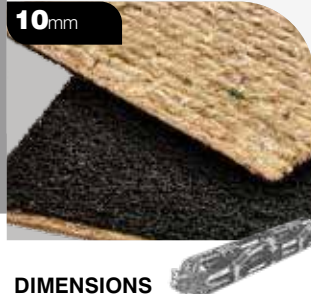

DIMENSIONS

Roll size 1.37 x 11m
= 15.07m²

APPLICATION

Usage BS 5808 Heavy contract (HC/U)
Traffic Residential or commercial

PERFORMANCE

Comfort ★★★★★
Durability ★★★★★★
Bounceback ★★★★★★
Heat Insulation 2.90 TOG
Sound reduction 34dB

Suitable for wheeled traffic

Product reference:
F9DS

duet

9mm

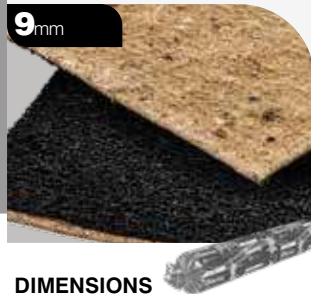

DIMENSIONS

Roll size 1.37 x 8m
= 11.00m²

APPLICATION

Usage BS 5808 Heavy contract (HC/U)
Traffic Residential or commercial

PERFORMANCE

Comfort ★★★
Durability ★★★★★★
Bounceback ★★★★★★
Heat Insulation 2.90 TOG
Sound reduction 32dB

Suitable for wheeled traffic

Product reference:
F9DU

HG

symphony

13.75mm



DIMENSIONS

Roll size 1.37 x 11m
= 15.07m²

APPLICATION

Usage BS 5808 Heavy contract (HC/U)
Traffic Residential or commercial

PERFORMANCE

Comfort ★★★★★
Durability ★★★★★
Bounceback ★★★★★
Heat Insulation 2.90 TOG
Sound reduction 38 dB

Suitable for wheeled traffic

Product reference:
F9SY56

symphony

13mm



DIMENSIONS

Roll size 1.37 x 11m
= 15.07m²

APPLICATION

Usage BS 5808 HEAVY CONTRACT (HC/U)
Traffic RESIDENTIAL OR COMMERCIAL

PERFORMANCE

COMFORT ★★★★★
DURABILITY ★★★★★
BOUNCEBACK ★★★★★
HEAT INSULATION 2.80 TOG
SOUND REDUCTION 35 dB

SUITABLE FOR WHEELED TRAFFIC

Product reference:
F9SY52

symphony

11mm



DIMENSIONS

Roll size 1.37 x 11m
= 15.07m²

APPLICATION

Usage BS 5808 Heavy contract (HC/U)
Traffic Residential or commercial

PERFORMANCE

Comfort ★★★★★
Durability ★★★★★
Bounceback ★★★★★
Heat Insulation 2.50 TOG
Sound reduction 32 dB

Suitable for wheeled traffic

Product reference:
F9SY54

Symphony 8mm (28oz), with 2.00 TOG and 28dB, is also available

For prices contact your nearest distributor – see back cover

For prices contact your nearest distributor – see back cover

Carpet Underlay Selector

Each Floorwise underlay has unique performance characteristics. We have included a recommendation table for you to be able to easily compare the underlays. Please note that generally the thicker the underlay, the better the underfoot comfort, whilst the greater the density the better the underlay will perform over time.

Key ✓✓ Recommended ✓ Suitable ✓* Stretch Fit installations only

The table includes a classification column, which rates the underlay to BS EN 14499 standards. Also included in the table are TOG ratings, with some underlays being better insulators than others. Finally, there is an impact sound rating, which is a guide to how well the underlay suppresses noise from the room above.

Range	Product	Use					Performance				Specification				
		GB	MB	L/DR	H/S/L	Commercial	Comfort	Durability	Bounceback	Thickness (mm)	Dimensions w x l = m ²	EN use BS5808	Roll weight (kg)	Heat insulation (TOG)	Sound reduction (dB)
Ultra High Density Plus UHD+	Elegance	✓✓	✓✓	✓✓	✓	✓*	****	*****	*****	10	1.37 x 11.0 = 15.07	LU	24.9	2.54	46
	Inspiration	✓✓	✓✓	✓✓	✓	✓*	****	*****	****	10	1.37 x 8.0 = 10.96	LU	40.5	1.71	46
	Prestige	✓✓	✓✓	✓✓	✓	✓*	****	*****	*****	11	1.37 x 7.3 = 10.00	LU	36.0	2.55	34
Super High Density Plus SHD+	Desire	✓✓	✓✓	✓✓	✓	✓*	***	*****	*****	9	1.37 x 11.0 = 15.07	LU	20.1	2.28	40
Ultra High Density Plus UHD+	Tread	✓✓	✓✓	✓✓	✓✓	✓	***	*****	*****	9	1.37 x 11.0 = 15.07	LU	25.1	2.41	39
	Lift [†]	✓✓	✓✓	✓✓	✓✓	✓✓	**	*****	*****	7	1.37 x 11.0 = 15.07	HC/U	19.8	2.12	37
Super High Density Plus SHD+	Allure	✓✓	✓✓	✓✓	✓	✓*	*****	*****	****	11	1.37 x 11.0 = 15.07	LU	23.0	2.53	46
	Supreme	✓✓	✓✓	✓✓	✓	✓*	*****	*****	****	11	1.37 x 11.0 = 15.07	LU	24.0	2.94	43
	Esteem	✓✓	✓✓	✓✓	✓	✓*	****	*****	****	10	1.37 x 11.0 = 15.07	LU	21.0	2.46	45
	Verve	✓✓	✓✓	✓✓	✓✓	✓*	***	*****	*****	9	1.37 x 11.0 = 15.07	LU	19.5	2.17	42
	Vitality	✓✓	✓✓	✓✓	✓✓	✓*	***	*****	*****	9	1.37 x 11.0 = 15.07	LU	19.7	2.32	39
Extra High Density Plus EHD+	Flexilay 11	✓✓	✓✓	✓✓	✓✓	✓*	*****	****	***	11	1.37 x 11.0 = 15.07	LU	21.0	3.64	45
	Maxi	✓✓	✓✓	✓✓	✓	✓*	*****	****	***	11	1.37 x 11.0 = 15.07	LU	19.8	3.64	45
	Flexilay 9	✓✓	✓✓	✓✓	✓	✓*	***	****	****	9	1.37 x 11.0 = 15.07	LU	17.4	2.75	41
	Traffic	✓✓	✓✓	✓✓	✓	✓*	***	****	****	9	1.37 x 11.0 = 15.07	LU	17.0	2.75	41
High Density Plus HD+	Lush	✓✓	✓✓	✓✓	✓	-	*****	***	**	12	1.37 x 11.0 = 15.07	LU	19.2	3.26	45
	Dash	✓✓	✓✓	✓✓	✓	-	*****	***	***	11	1.37 x 11.0 = 15.07	LU	17.6	2.85	42
	Panache	✓✓	✓✓	✓✓	✓	-	****	***	***	10	1.37 x 11.0 = 15.07	LU	15.7	2.51	44
	Spirit	✓✓	✓✓	✓✓	✓	-	****	***	***	10	1.37 x 11.0 = 15.07	LU	16.0	2.51	36
	Lusso	✓✓	✓✓	✓✓	✓	-	****	***	**	10	1.37 x 11.0 = 15.07	GD/U	15.6	2.56	38
	Bravo	✓✓	✓✓	✓✓	✓	-	***	***	***	9	1.37 x 11.0 = 15.07	GD/U	12.2	2.22	37
	Style	✓✓	✓✓	✓✓	✓	-	***	***	***	8	1.37 x 11.0 = 15.07	GD/U	12.6	2.23	37
	Solo	✓✓	✓✓	✓✓	✓	-	***	***	***	8	1.37 x 11.0 = 15.07	GD/U	12.8	2.23	37
	Prima	✓✓	✓✓	✓✓	✓	-	**	***	***	8	1.37 x 11.0 = 15.07	GD/U	12.5	2.01	37

All products are recommended for use in GB - General Bedroom, MB - Master Bedroom, L/DR - Lounge/Dining Room, H/S/L Hall/Stairs/Landing, Comm - Commercial Use.

[†]Suitable for double stick applications

Carpet Underlay Selector

Each Floorwise underlay has unique performance characteristics. We have included a recommendation table for you to be able to easily compare the underlays. Please note that generally the thicker the underlay, the better the underfoot comfort, whilst the greater the density the better the underlay will perform over time.

Key ✓✓ Recommended ✓ Suitable ✓* Stretch Fit installations only

The table includes a classification column, which rates the underlay to BS EN 14499 standards. Also included in the table are TOG ratings, with some underlays being better insulators than others. Finally, there is an impact sound rating, which is a guide to how well the underlay suppresses noise from the room above.

Range	Product	Use					Performance				Specification				
		GB	MB	L/DR	H/S/L	Commercial	Comfort	Durability	Bounceback	Thickness (mm)	Dimensions w x l = m ²	EN use BS5808	Roll weight (kg)	Heat insulation (TOG)	Sound reduction (dB)
PU foam MD+	Medium Density Plus Attivo	✓✓	✓	✓✓	✓	-	****	**	**	10	1.37 x 11.0 = 15.07	GD/U	12.9	2.68	41
	Essentials 10	✓✓	✓	✓✓	✓	-	****	**	**	10	1.37 x 11.0 = 15.07	GD/U	12.8	2.37	41
	Senso	✓✓	✓	✓✓	✓	-	**	**	**	8	1.37 x 11.0 = 15.07	GD/U	10.5	2.23	36
	Essentials 8	✓✓	✓	✓✓	✓	-	**	**	**	8	1.37 x 11.0 = 15.07	GD/U	10.9	1.94	36
Rubber UHD+	Ultra High Density Plus Champion [†]	✓✓	✓✓	✓✓	✓✓	✓	***	*****	*****	8	1.37 x 8.0 = 10.96	HC/U	34.0	1.31	33
	Optima [†]	✓✓	✓✓	✓✓	✓✓	✓	***	*****	*****	8	1.37 x 8.0 = 10.96	HC/U	34.0	1.45	34
	Vigour [†]	✓✓	✓✓	✓✓	✓✓	✓✓	**	*****	*****	6.75	1.37 x 11.0 = 15.07	HC/U	36.5	1.19	30
	Endura [†]	✓✓	✓✓	✓✓	✓✓	✓✓	**	*****	*****	6.75	1.37 x 11.0 = 15.07	HC/U	39.0	1.26	32
	Pinnacle	✓✓	✓✓	✓✓	✓	✓*	****	*****	****	10	1.33 x 8.24 = 10.96	L/U	40.5	1.54	38
	Thermaflow Impact	✓✓	✓✓	✓✓	✓✓	✓	**	*****	*****	6.75	1.33 x 8.24 = 10.96	HC/U	39.0	0.79	34
Crumb rubber Wool felt UHD+	Ultra High Density Plus Duet Sovereign	✓✓	✓✓	✓✓	✓	✓*	****	*****	*****	11	1.37 x 7.3 = 10.00	HC/U	24.0	2.95	34
	Duet Supreme	✓✓	✓✓	✓✓	✓	✓*	****	*****	*****	10	1.37 x 11.0 = 15.07	HC/U	36.2	2.90	34
	Duet	✓✓	✓✓	✓✓	✓	✓*	***	*****	*****	9	1.37 x 11.0 = 15.07	HC/U	30.2	2.90	32
Wool felt HD+	High Density Plus Symphony 56	✓✓	✓✓	✓✓	✓	✓*	****	****	****	13.75	1.37 x 11.0 = 15.07	HC/U	28.6	2.90	38
	Symphony 52	✓✓	✓✓	✓✓	✓✓	✓*	****	****	****	13	1.37 x 11.0 = 15.07	HC/U	25.2	2.80	35
	Symphony 42	✓✓	✓✓	✓✓	✓✓	✓*	***	****	***	11	1.37 x 11.0 = 15.07	HC/U	21.5	2.50	32
	Medium Density Plus Symphony 28	✓✓	✓	✓✓	✓	✓*	**	****	***	8	1.37 x 11.0 = 15.07	GC/U	14.3	2.00	28

All products are recommended for use in GB - General Bedroom, MB - Master Bedroom, L/DR - Lounge/Dining Room, H/S/L Hall/Stairs/Landing, Comm - Commercial Use.

[†]Suitable for double stick applications

Wood, Laminate and LVT Underlays

Acoustica	25
Whisper	28

Floorwise brings together a wide range of different types of wood/laminate underlays.

Floorwise brings together a wide range of different types of specialist underlay for use under Wood, Laminate and LVT flooring. These underlays are thinner than those used under carpets and are ideal for helping to provide cushioned support and absorbing minor surface imperfections making for an easy installation that will prolong the life of your floorcovering. Equally importantly they will significantly reduce the sound made by wood, laminate & LVT floorcoverings making for a nicer living environment.

The Floorwise acoustica range of dense rubber underlays are excellent at absorbing noise, both between floors by way of impact sound reduction and within the room through airborne noise reduction.

The Whisper range of PE foam underlays are also very good at absorbing impact noise but do not perform to the same standards as the Acoustica range for airborne sound. The Floorwise range of wood, Laminate and LVT Underlays is all rated according to our Sound Reduction guide to help decide which product will be best for your project.



Ultimate Sound Reduction



Premium Sound Reduction



Enhanced Sound Reduction



Good Sound Reduction



Basic Sound Reduction



Acoustica Underlays



acoustica platinum

3.75mm



Sponge rubber

DIMENSIONS

Roll size 1.37 x 11.00m
= 15.07m²

Thickness 3.75mm
Density 707 kg/m³

APPLICATION

- Ultimate airborne sound
- Built in water vapour barrier
- Absorbs minor floor imperfections

PERFORMANCE

Support *****
Impact Sound Reduction *****
Airborne Sound *****

Heat insulation 0.27 TOG
Sound reduction 23dB
Comfort Good

Product reference:
F9ACP

acoustica gold supreme

3.5mm



Rubber crumb

DIMENSIONS

Roll size 1.0 x 10.00m
= 10m²

Thickness 3.50mm
Density 350 kg/m³

APPLICATION

- Ultimate airborne sound
- Built in water vapour barrier
- Absorbs minor floor imperfections

PERFORMANCE

Support *****
Impact Sound Reduction *****
Airborne Sound *****

Heat insulation 0.80 TOG
Sound reduction 23dB
Comfort Good

Product reference:
F9ACGS

acoustica gold excel

3.5mm



Sponge rubber

DIMENSIONS

Roll size 1 x 10m = 10m²

Thickness 3.50mm
Density 900 kg/m³

APPLICATION

- Ultimate airborne sound
- Built in water vapour barrier
- Absorbs minor floor imperfections

PERFORMANCE

Support *****
Impact Sound Reduction ****
Airborne Sound *****

Heat insulation 0.39 TOG
Sound reduction 21dB
Comfort Good

Product reference:
F9ACGE

For prices contact your nearest distributor – see back cover



Acoustica Underlays



PSR+

acoustica gold
3.00mm

Sponge rubber

DIMENSIONS
Roll size 1.37 x 7.30m
 = 10.00m²
 0,685 x 14.6
 = 10.00m²
Thickness 3.00mm
Density 735 kg/m³

APPLICATION
 - Premium airborne sound
 - Built in water vapour barrier
 - Absorbs minor floor imperfections

PERFORMANCE
Support *****
Impact Sound ***
Reduction
Airborne Sound *****
Heat insulation 0.26 TOG
Sound reduction 20dB
Comfort Good

Product reference:
F9ACG

ESR+

acoustica silver supreme
3.00mm

Rubber crumb

DIMENSIONS
Roll size 1.0 x 10.0m
 = 10.00m²
Thickness 3.00mm
Density 350 kg/m³

APPLICATION
 - Premium airborne sound
 - Built in water vapour barrier
 - Absorbs minor floor imperfections

PERFORMANCE
Support *****
Impact Sound *****
Reduction
Airborne Sound *****
Heat insulation 0.70 TOG
Sound reduction 22dB
Comfort Good

Product reference:
F9ACSS

ESR+

acoustica silver
2.5mm

Sponge rubber

DIMENSIONS
Roll size 1 x 10m =
 10.00m²
Thickness 2.5mm
Density 925 kg/m³

APPLICATION
 - Premium airborne sound
 - Built in water vapour barrier
 - Absorbs minor floor imperfections

PERFORMANCE
Support *****
Impact Sound **
Reduction
Airborne Sound ***
Heat insulation 0.30 TOG
Sound reduction 18dB
Comfort Good

Product reference:
F9ACSE

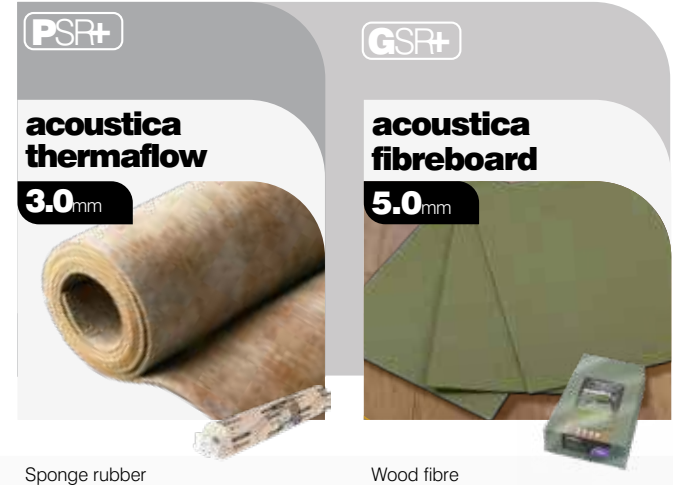

PSR+

acoustica thermaflow
3.0mm

Sponge rubber

DIMENSIONS
Roll size 1.37 x 11.00m
 = 15.07m²
Thickness 3.00mm
Density 735 kg/m³

APPLICATION
 - Premium airborne sound
 - Absorbs minor floor imperfections

PERFORMANCE
Support *****
Impact Sound ***
Reduction
Airborne Sound *****
Heat insulation 0.25 TOG
Sound reduction 20dB
Comfort Good

Product reference:
F9ACB

GSR+

acoustica fibreboard
5.0mm

Wood fibre

DIMENSIONS
Panel size 0.59 x 0.85m
 x 20 = 10.03m²
Thickness 5.0mm
Density 250 kg/m³

APPLICATION
 - Absorbs minor floor imperfections

PERFORMANCE
Support *****
Impact Sound *****
Reduction
Airborne Sound ***
Heat insulation 0.50 TOG
Sound reduction 22dB
Comfort Good

Product reference:
F9AFB

Whisper Underlays

ESR+

whisper gold ultra

3.0mm



EVA foam

DIMENSIONS

Roll size 1 x 10m
= 10.00m²
Thickness 3.00mm
Density 100 kg/m³

APPLICATION

- Enhanced airborne sound
- Built in water vapour barrier
- Absorbs minor floor imperfections

PERFORMANCE

Support *****
Impact Sound Reduction ****
Airborne Sound ****

Heat insulation 1.20 TOG
Sound reduction 21dB
Comfort Excellent

Product reference:
F9WG

GSR+

whisper silver

3.0mm



EPE foam

DIMENSIONS

Roll size 1 x 10m
= 10.00m²
Thickness 3.00mm
Density 30 kg/m³

APPLICATION

- Good airborne sound
- Built in water vapour barrier
- Absorbs minor floor imperfections

PERFORMANCE

Support *****
Impact Sound Reduction **
Airborne Sound ***

Heat insulation 0.80 TOG
Sound reduction 19dB
Comfort Excellent

Product reference:
F9SE

whisper green barrier

3.0mm



EPE foam

DIMENSIONS

Roll size 1 x 15m
= 15.00m²
Thickness 3.00mm
Density 30 kg/m³

APPLICATION

- Good airborne sound
- Built in water vapour barrier
- Absorbs minor floor imperfections

PERFORMANCE

Support *****
Impact Sound Reduction **
Airborne Sound ***

Heat insulation 0.80 TOG
Sound reduction 19dB
Comfort Excellent

Product reference:
FW9WGBE

whisper thermaflow

3.0mm



IXPE foam

DIMENSIONS

Roll size 1 x 10m
= 10.00m²
Thickness 3.00mm
Density 35 kg/m³

APPLICATION

- Good airborne sound
- Built in water vapour barrier
- Absorbs minor floor imperfections

PERFORMANCE

Support *****
Impact Sound Reduction *****
Airborne Sound ***

Heat insulation 0.30 TOG
Sound reduction 23dB
Comfort Excellent

Product reference:
F9WT

floor guard floor protection system

2.0mm



MDPE foam with woven PE facing

DIMENSIONS

Roll size 1 x 30m
= 30.00m²
Thickness 2.00mm
Density 56 kg/m³

APPLICATION

- Protects your floor from traffic damage
- Provides a safe temporary surface
- Built-in overlap to make installation easy
- Integral self-adhesive tape jointing system
- No adhesive residue left on the floor
- Quick & easy to roll out

Wood, Laminate and LVT Selector

Each Floorwise underlay has unique performance characteristics. We have included a recommendation table for you to be able to easily compare the underlays. Please note that generally the denser the underlay the better it is at reducing sound, which is why Rubber underlays are generally the best option for this application.

Range	Product	Use						Performance				Specification				
		Material	GB	MB	L/DR	H/S/L	Commercial	Support	Impact Sound Reduction	Airborne Sound Reduction	Moisture barrier	Thickness mm	Dimensions w x l = m ²	Density kg/m ³	Roll weight kg	TOG
Acoustica Platinum 	Sponge Rubber	✓✓	✓✓	✓✓	✓✓	✓✓	*****	*****	*****	✓	3.75	1.37 x 11.0 = 15.07	707	38.3	0.27	23
Acoustica Gold Supreme 	Rubber Crumb	✓✓	✓✓	✓✓	✓✓	✓✓	*****	*****	*****	✓	3.50	1.0 x 10.0 = 10.00	350	12.3	0.80	23
Acoustica Gold Excel 	Sponge Rubber	✓✓	✓✓	✓✓	✓✓	✓✓	*****	****	*****	✓	3.50	1.0 x 10.0 = 10.00	900	25.0	0.39	21
Acoustica Gold 	Sponge Rubber	✓✓	✓✓	✓✓	✓✓	✓✓	*****	***	*****	✓	3.00	0.685 x 14.6 = 10.00 1.37 x 7.30 = 10.00	735	21.4	0.26	20
Acoustica Silver Supreme 	Rubber Crumb	✓✓	✓✓	✓✓	✓✓	✓✓	*****	*****	*****	✓	3.00	1.0 x 10.0 = 10.00	350	11.0	0.70	22
Acoustica Silver 	Sponge Rubber	✓✓	✓✓	✓✓	✓✓	✓✓	*****	**	***	✓	2.50	1.0 x 10.0 = 10.00	925	18.5	0.30	18
Acoustica Thermaflow 	Sponge Rubber	✓✓	✓✓	✓✓	✓✓	✓✓	*****	***	*****	-	3.00	1.37 x 11 = 15.07	735	32.2	0.25	20
Acoustica Fibreboard 	Wood Fibre	✓✓	✓✓	✓✓	✓✓	✓✓	*****	*****	***	-	5.00	0.59 x 0.85 x 20 = 10.03	250	12.5	0.50	22

All products are recommended for use in GB - General Bedroom, MB - Master Bedroom, L/DR - Lounge/Dining Room, H/S/L Hall/Stairs/Landing, Comm - Commercial Use.

Wood, Laminate and LVT Selector

Each Floorwise underlay has unique performance characteristics. We have included a recommendation table for you to be able to easily compare the underlays. Please note that generally the denser the underlay the better it is at reducing sound, which is why Rubber underlays are generally the best option for this application.

Range	Product	Use						Performance				Specification				
		Material	GB	MB	L/DR	H/S/L	Commercial	Support	Impact Sound Reduction	Airborne Sound Reduction	Moisture barrier	Thickness mm	Dimensions w x l = m ²	Density kg/m ³	Roll weight kg	TOG
Whisper Gold Ultra 	EVA Foam	✓✓	✓✓	✓✓	✓✓	✓✓	*****	****	****	✓	3.00	1.0 x 10.0 = 10.00	100	3.0	1.20	21
Whisper Silver 	EPE Foam	✓✓	✓✓	✓✓	✓✓	✓	*****	**	***	✓	3.00	1.0 x 10.0 = 10.00	30	0.9	0.80	19
Whisper Green Barrier 	EPE Foam	✓✓	✓✓	✓✓	✓✓	✓	*****	**	***	✓	3.00	1.0 x 15.0 = 15.00	30	1.35	0.80	19
Whisper Thermaflow 	IXPE Foam	✓✓	✓✓	✓✓	✓✓	✓	*****	*****	***	✓	3.00	1.0 x 10.0 = 10.00	35	1.40	0.30	23

All products are recommended for use in GB - General Bedroom, MB - Master Bedroom, L/DR - Lounge/Dining Room, H/S/L Hall/Stairs/Landing, Comm - Commercial Use.

Plywood, Hardboard and Paper Felt

SP101 Flooring Plywood

5.5mm



DESCRIPTION

SP101 Flooring Plywood® has been developed to exceed BS8203 standards as a fully reliable substrate meant for use in the subfloor preparation in readiness for all types of floorcovering.

Available in a range of thicknesses and sizes.

BENEFITS

- ✓ Meets BS8203: 2017 – Plywood Annexe A
- ✓ TFT Woodexperts Diamond Mark Certified
- ✓ High quality face veneers
- ✓ Reliable glue line performance
- ✓ Accurate dimensional tolerances
- ✓ Recommended by most flooring manufacturers

Hardboard

3.2mm



DESCRIPTION

Our hardboard is a versatile general purpose fibreboard usually used for levelling uneven floorboards.

Paper Felt



DESCRIPTION

Our quality lining paper helps protect the subfloor and prevents dust from rising through the floorboards. Available in a range of weights and roll sizes.

Weights

- 175 gsm - 1m x 50m
- 175 gsm - 1m x 100m
- 150gsm - 2m x 100m

Scotia

F541 Scotia



DESCRIPTION

Wood foiled
16.5mm x 16.5mm x 2.4m

Used to cover the expansion gap on wood and laminate floors.

Available in a wide range of decors, ask your local distributor for a set of colour samples.



For prices contact your nearest distributor – see back cover

Adhesives and Screeds

Screeds	36
Adhesives	46

Floorwise supply the flooring professional with a versatile range of high-quality adhesives and levelling compounds that won't let you down on the job!

All Flooring Professionals know that the perfect finish needs a perfect subfloor and our range of screeds and levelling compounds cover every need in order to achieve this.

Next they require is an adhesive that holds fast and lasts the course – contractors who try Floorwise adhesives stick with them.

Floorwise won't let you down when it comes to product quality, availability or supply.



pro-screed

Ultra

F5ULTRA
Pro-Screed Ultra 2-part rapid setting latex polymer levelling & smoothing compound

F5ULTRALL
pro-screed ultra latex liquid

Pro-Screed Ultra is a rapid-setting, 2-part latex polymer levelling and smoothing compound with excellent flow and adhesion properties.

- **Rapid Setting**
Walk on after 80 minutes
Install floorcoverings after 3 hours
- **Long open time**
For ease of use
- **Application depth**
2 - 22mm
- **Excellent flow**
And application properties
- **Suitable for use**
Over old adhesive residues
- **Moisture tolerant**
Can be used above and below DPMs
- **No priming necessary**
On most subfloors
- **Perfect for timber substrates**
- **Suitable for use**
With underfloor heating systems
- **Very low odour**

WALK ON TIME: 80 minutes

WORKING TIME: Approximately 20 minutes

APPLY FLOORCOVERING: Typically 3 hours
(2 hours for ceramic tiles)

COMPRESSIVE STRENGTH: c20 after 28 days

APPLICATION THICKNESS: 2mm to 22mm

COVERAGE:	Thickness	Approx.
	2mm	6.75m ²
	3mm	4.5m ²
	5mm	2.7m ²
	10mm	1.35m ²
	22mm	0.61m ²

Please scan for installation guide



20kg



4.5L

pro-screed

Xtra

F5XTRA
Pro-Screed Xtra Rapid setting fibre reinforced water-based levelling & smoothing compound

Pro-Screed Xtra is a rapid-setting, single part, fibre reinforced, water based levelling and smoothing compound with excellent flow and adhesion properties

- **Rapid Setting**
Walk on after 80 minutes
Install floorcoverings after 3 hours
- **Application depth**
2 - 55mm
- **Excellent flow**
And application properties
- **Fibre reinforced**
With flexible properties
- **Moisture tolerant**
Can be used above and below DPMs
- **Suitable for use**
With underfloor heating systems
- **Very low odour**
- **Protein, ammonia & casein free**

WALK ON TIME:	80 minutes	
WORKING TIME:	Approximately 20 minutes	
APPLY FLOORCOVERING:	Typically 3 hours (2 hours for ceramic tiles)	
COMPRESSIVE STRENGTH:	c25 after 28 days	
APPLICATION THICKNESS:	2mm to 55mm	
COVERAGE:	Thickness	Approx.
	2mm	6.75m ²
	3mm	4.5m ²
	5mm	2.7m ²
	10mm	1.35m ²
	20mm	0.67m ²
	55mm	0.25m ²

Please scan for installation guide



20kg

pro-screed

Gold

F5GOLD
Pro-Screed Gold2 Part rapid setting latex polymer levelling & smoothing compound

F5GOLDLL
Pro-Screed Gold Latex Liquid

Pro-Screed Gold is a versatile 2 part latex polymer levelling and smoothing compound with excellent flow and adhesion properties.

- **Rapid Setting**
Walk on after 90 minutes
Install floorcoverings after 4 hours
- **Excellent flow**
and application properties
- **Suitable for use**
over old adhesive residues
- **Moisture tolerant**
can be used below and over DPMs
- **No priming necessary**
on most subfloors
- **Perfect for timber substrates**
- **Suitable for use**
with Underfloor heating systems
- **Low odour**
- **Protein, ammonia & casein free**

WALK ON TIME:	90 minutes	
WORKING TIME:	Approximately 20 minutes	
APPLY FLOORCOVERING:	Typically 4 hours (2 hours for ceramic tiles)	
COMPRESSIVE STRENGTH:	c16 after 28 days	
APPLICATION THICKNESS:	Featheredge to 10mm unfilled From 10mm to 30mm filled (3mm granite chippings)	
COVERAGE:	Thickness	Approx.
	5m ²	3mm
	20kg bag + 5L liquid	

Please scan for installation guide



20kg



4.5L

pro-screed

Dura

F5DURA
Pro-Screed Dura 2-part fast setting latex polymer levelling & smoothing compound

F5DURALL
Pro-Screed Dura Latex Liquid

Pro-Screed Dura is a fast-setting, 2 part latex polymer levelling and smoothing compound with excellent flow and adhesion properties.

- **Fast Setting**
Walk on after 2 hours
Install floorcovering after 6 hours
- **Application depth**
2 - 15mm
- **Excellent flow**
And application properties
- **Suitable for use**
With underfloor heating systems over solid substrates
- **Very low odour**
- **Protein, ammonia & casein free**

WALK ON TIME:	2 hours	
WORKING TIME:	Approximately 25 minutes	
APPLY FLOORCOVERING:	Typically 6 hours (4 hours for ceramic tiles)	
COMPRESSIVE STRENGTH:	c25 after 28 days	
APPLICATION THICKNESS:	2mm to 15mm	
COVERAGE:	Thickness	Approx.
	2mm	6.75m ²
	3mm	4.5m ²
	5mm	2.7m ²
	10mm	1.35m ²
	15mm	0.90m ²

Please scan for installation guide



20kg



4.5L

pro-screed

Feather

F5FEA
Pro-Screed Feather ultra fine rapid setting smoothing & patch repair compound

Pro-Screed Feather is an ultra-fine, rapid-setting, high polymer, smoothing and patch repair compound.

- **Rapid setting**
Install floorcoverings after 15 minutes
- **Application depth**
0 - 3mm
- **Excellent adhesion properties**
- **Perfect for timber substrates**
- **Suitable for use**
With underfloor heating systems
- **Protein free**

WALK ON TIME:	15 minutes
WORKING TIME:	Approximately 10 minutes
APPLY FLOORCOVERING:	Typically 15 minutes
COMPRESSIVE STRENGTH:	c16 after 28 days
APPLICATION THICKNESS:	0mm to 3mm
COVERAGE:	Scratch coat 50m ²

Please scan for installation guide



11kg



5kg

pro-screed

Prime

F5PRIME
Pro-Screed Prime advanced primer
for porous surfaces

Pro-Screed Prime is a highly advanced primer to stabilise, seal and prepare porous subfloors prior to the application of levelling compounds.

- **Rapid drying** after just 30 minutes
- Designed to **prime, stabilise and seal** porous subfloors
- **Increases the adhesion** of flooring compounds
- **Prolongs the working time**
- **Pigmented** for ease of application

WALK ON TIME: 30 minutes

WORKING TIME: Approximately 10 minutes

APPLY LEVELLING COMPOUND: Typically 30 minutes

COVERAGE DILUTED WITH 3 PARTS WATER: 220m²

Please scan for installation guide



5L

Prime&Grab

F5PRIME
Pro-Screed Prime advanced primer
for porous surfaces

Pro-Screed Prime&Grab is a highly advanced primer to stabilise, seal and prepare non-porous substrates prior to the application of smoothing and levelling compounds.

- **Rapid drying** after just 45 minutes
- Designed to **prime, stabilise and seal** porous subfloors
- **Increases the adhesion** of flooring compounds
- **Prolongs the working time**
- **Pigmented** for ease of application

WALK ON TIME: 45 minutes

WORKING TIME: Approximately 10 minutes

APPLY LEVELLING COMPOUND: Typically 45 minutes

COVERAGE DILUTED WITH 3 PARTS WATER: 62.5m²

Please scan for installation guide



5L

floorwise

Suitability guide

Product	F5ULTRA	F5XTRA	F5GOLD	F5DURA	F5FEA
Size	20kg & 4.5L	20kg	20kg & 5L	20kg & 4.5L	11kg
Coverage	4.5m ² @3mm	4.5m ² @3mm	5m ² @3mm	4.5m ² @3mm	50m ² @Scratch
Working time at 20°C	20 minutes	20 minutes	20 minutes	25 minutes	10 minutes
Time to foot traffic at 20°C	80 minutes	80 minutes	90 minutes	120 minutes	15 minutes
Time to lay floorcovering					
Resilient	3 hours	3 hours	4 hours	6 hours	15 minutes
Ceramics	2 hours	2 hours	3 hours	4 hours	15 minutes
Application thickness					
Minimum (mm)	2mm	2mm	2mm	2mm	0mm
Maximum (mm)	22mm	55mm	12/30mm**	15mm	3mm
Compressive strength 28 days	c20	c25	c16	c25	c16
Flexural strength 20 days	F7	F7	F7	F7	F6
EN 13813 Class / EN 1504-3 class **with aggregate	CT-C20-F7	CT-C25-F7	CT-C16-F7	CT-C25-F7	CT-C16-F6
Application method					
Trowel	✓	✓	✓	✓	✓
Pump application	✓	✓	-	✓	-
Aeration roller (recommended)	✓	✓	✓	✓	-
Product characteristics					
Rapid setting	✓	✓	✓	-	✓
Walk on	80 minutes	80 minutes	90 minutes	120 minutes	15 minutes
Install resilient floorcoverings/ceramics	3/2 hours	3/2 hours	4/3 hours	6/4 hours	15 minutes
Excellent Flow	✓	✓	✓	✓	-
Suitable for use over old adhesive residues	✓	✓	✓	-	-
No priming necessary	✓	-	✓	-	✓
Suitable for rigid timber substrates	✓	✓	✓	-	✓
Suitable for use with underfloor heating	✓	✓	✓	-	✓
Suitable for biologically sensitive areas	✓	✓	✓	✓	✓
Suitable for high temperature areas	✓	✓	✓	✓	✓
Moisture tolerant – can be used below and above	✓	✓	✓	✓	✓
Low odour	✓	✓	✓	-	-
Protein, ammonia & casein free	✓	✓	✓	✓	?
Sub floor suitability					
Concrete, sand/cement screeds	✓	✓*4	✓	✓	✓
Power floated concrete	✓*1	✓*1*4	✓*1	✓*1	-
Ceramics, porcelain, terrazzo, marble, granolithic & natural stone	✓	✓*3	✓	✓	✓
Calcium sulphate/Anhydrite floors	✓*2	✓*2	✓*2	✓*2	✓*2
Old adhesive residues (moisture tolerant)	✓	-	✓	-	-
Surface DPM, epoxy and polyurethane coatings	✓	✓*3	✓	✓*3	-
Flooring grade plywood	✓	✓*4	✓	-	✓
Rigid timber floors	✓	✓*4	✓	-	✓
Rigid vinyl tiles	✓	✓*3	✓	-	✓
Rigid steel/metal (non-flexing & corrosion free)	✓*3	✓*3	✓*3	-	-
Flooring grade asphalt/bitumen	✓	✓*3	✓	✓	-
Fibre cement sheet & tile backing boards	✓	✓*3	✓	✓	✓

*1 Mechanically abrade first (shot blast)

*2 Remove laitance and use special primer

*3 Prime first with Pro-Screed Prime & Grab

*4 Prime first with Pro-Screed Prime

Adhesives and Screeds

Product type and range	Product description	Product code	Coverage m ²	Pack size	
Levelling and smoothing					
Ultra	Pro-Screed Ultra 2-part rapid setting latex polymer levelling & smoothing compound	F5ULTRALL	Thickness 2mm 3mm 5mm	Approximate 6.75m ² 4.5m ² 2.7m ²	20kg bag
	Pro-Screed Ultra Latex Liquid	F5ULTRALL	10mm 22mm	1.35m ² 0.61m ²	4L tub
Xtra	Pro-Screed Xtra Rapid setting fibre reinforced water-based levelling & smoothing compound	F5XTRA	Thickness 2mm 3mm 5mm 10mm 20mm 55mm	Approximate 6.75m ² 4.5m ² 2.7m ² 1.35m ² 0.67m ² 0.25m ²	20kg bag
Gold	Pro-Screed Gold 2 Part rapid setting latex polymer levelling & smoothing compound	F5GOLD			20kg bag
	Pro-Screed Gold Latex Liquid	F5GOLDLL		5m ² @ 3mm per 20kg bag + 5l liquid	5L tub
Dura	Pro-Screed Dura 2-part fast setting latex polymer levelling & smoothing compound	F5DURA	Thickness 2mm 3mm 5mm	Approximate 6.75m ² 4.5m ² 2.7m ²	20kg bag
	Pro-Screed Dura Latex Liquid	F5DURALL	10mm 15mm	1.35m ² 0.90m ²	4.5L tub
Feather	Pro-Screed Feather ultra fine rapid setting smoothing & patch repair compound	F5FEA			Scratch coat 50m ² 11kg bag
Prime	Pro-Screed Prime advanced primer for porous surfaces	F5PRIME			220m ² 5L tub
Prime & Grab	Pro-Screed priming and bonding agent with textured surface	F5PRIGRAB			62.5m ² 5L tub
Mixing bucket	Pro-Screed mixing bucket. 42 litre capacity allows mixing of 2 full bags simultaneously	F5MIX			42 litres 42 litre tub

F599 Heavy Duty Spray Adhesive

Heavy Duty Spray Adhesive

This market-leading Floorwise heavy duty spray adhesive can be used to fix a wide variety of floor coverings onto most sub floor types. This is thanks to F599 offering a higher percentage of solids than many other spray adhesives giving it a competitive advantage.

Floorwise won't let you down when it comes to product quality, availability or supply.

COVERAGE : Approx. 3m² per can onto a single non-porous surface

- Higher solids providing you more adhesive per can
- Higher coat weight giving you more surface adhesive
- Excellent bond strength
- Super quick drying

Not suitable for highly plasticised Vinyls or PVC



500ml

F597 DCM Free Heavy Duty Spray Adhesive

Heavy Duty Spray Adhesive

F597 removes the dichloromethane taking away the hazards associated with many spray adhesives of being potentially harmful to both health and the environment without any loss of adhesive performance.

The other safety benefit for flooring contractors is that the new solvent is lighter than air so disperses quickly into the atmosphere. In contrast DCM is odourless and heavier than air so pools at ground level where it forms an invisible layer which, when inhaled, can lead to health issues for installers working at floor level in poorly ventilated or confined spaces.

COVERAGE : Approx. 3m² per can onto a single non-porous surface





- DCM Free
- Higher solids providing you more adhesive per can
- Higher coat weight giving you more surface adhesive
- Excellent bond strength
- Super quick drying

Not suitable for highly plasticised Vinyls or PVC



500ml

Adhesives and Screeds

Product type	Product range	Product code	Coverage m ²	Pack size
Application				
	Heavy Duty Spray Adhesive	F599	Approx. 3m ² per can onto a single non-porous surface	500ml can
	Environmentally Friendly Heavy Duty Spray Adhesive without Dichloromethane	F597	Approx. 3m ² per can onto a single non-porous surface	500ml can
	Contact Spray Adhesive	F592	Approx. 3m ² per can onto a single non-porous surface	500ml can
	Solvent Cleaner	F590	-	500ml can
	Vinyl Spray Adhesive	F595	Approx. 3m ² per can onto a single non-porous surface	500ml can
	Heavy Duty Spray Adhesive	F596	Approx. 3m ² per can onto a single non-porous surface	500ml can
	Spray Adhesive	F598	Approx. 3m ² per can onto a single non-porous surface	500ml can
	Silicone Joint Sealant - Clear or White	F500	Approx. 11 Linear metres of a 6mm bead	310 ml cartridge
	Contact Spray Adhesive	F592C	Approx. 100-150m ² on a single sided application per 19.5L canister, dependent upon the porosity of the subfloor.	17kg
	Super Contact Spray Adhesive	F593C	Approx. 100-150m ² on a single sided application per 19.5L canister, dependent upon the porosity of the subfloor.	17kg
	Carpet Tackifier Spray Adhesive	F594C	Approx. 300-500m ² on a single sided application per 19.5L canister, dependent upon the weight of application and porosity of the subfloor.	13kg
	Standard Gun for spray canisters	F7252	-	Spray gun head
	Premium Gun for spray canisters	F7251	-	Spray gun head
	Standard Gun & Wand for spray canisters	F7253	-	Spray gun head and wand
	12ft Hose for spray canisters	F7254/12	-	1 hose
	18ft Hose for spray canisters	F7254/18	-	1 hose

Gripper

Diamond Gripper	51
Premium Gripper	51

Floorwise supplies a range gripper options to suit almost any installation.

Diamond Gripper

Our standard Diamond Gripper range is both thicker at 6.3mm and wider at 25mm than most other grippers but it also has up to 20% more pins and nails than found on an entry level standard gripper.

The range also includes a pre-cut stick down option for where nails are not an option as well as our XL9 product with a 9mm thick plywood base but with the same high pin and nail count making it ideal for use with thicker underlays - both of these options give all the benefits you expect of Diamond Gripper.

The pre-set fixing nails are designed for use with concrete, timber or mixed flooring substrates making it easier to install. Similarly the pins are zinc coated for added durability and have a choice of medium or long pins to suit differing carpet types providing greater long-term stability for the carpet thereby extending its service life.

We recommend using Diamond Gripper for commercial power stretching installations

Premium Gripper

The Floorwise Premium Gripper range is again thicker at 6.0mm and wider at 22mm with more pins and nails than you would find in a standard budget gripper. The pre-set fixing nails designed for use with concrete, timber or mixed flooring substrates make it easier to install whilst the increased pin count and option for short, medium or long pins to suit the individual carpet type offers greater long-term stability for the carpet.



Gripper

Product		Specification	
Code	Product name	Pins/nails	Nail length mm
TIMBER FLOORS			
F180	Diamond Gripper XL9 Pre-nailed, Medium pin	78/12	25
F160	Diamond Gripper Pre-nailed, Medium Pin	78/12	25
F150	Premium Gripper, Pre-nailed, Medium Pin	65/10	22
F157	Premium Gripper, Pre-nailed, Short Pin	65/10	22
F153	Premium Gripper, Pre-nailed, Long Pin	65/10	22
CONCRETE FLOORS			
F161	Diamond Gripper Pre-nailed, Medium Pin	78/12	25
F151	Premium Gripper, Pre-nailed, Medium Pin	65/10	22
DUAL PURPOSE (TIMBER/CONCRETE)			
F182	Diamond Gripper XL9, Pre-nailed, Medium Pin	78/12	25
F167	Diamond Gripper, Pre-nailed, Medium Pin	78/12	25
F162	Premium Gripper, Pre-nailed, Medium Pin	65/10	25
STICK DOWN & BLIND GRIPPER			
F152	Stick Down Gripper, Medium Pin	65/10	N/A
F190	Blind Gripper, DP Nails	0/10	22
F152PC	Stick down pre-cut gripper	65/0	N/A



For prices contact your nearest distributor – see back cover



Profiles

Max Reflections	53
Max	54
Classic	56
Zenith	58
Flexible PVC	60

Providing that finishing touch for all types of floor coverings.

Floorwise profiles are made to the highest standards. Crafted from premium quality metals, our profiles are easy to handle and deliver longer lasting use.

Wrapped in protective film to keep damage and unsightly scratches at bay, Floorwise profiles are packed to arrive in perfect condition.

max Reflections profile range

Give your room the ultimate makeover and co-ordinate with metallic fixtures and fittings using Max Reflections.

the max profile range

Where strength and rigidity are a must, make sure it's the Max.

the Classic profile range

A precision blend of performance and value, the Classic Profile Range includes some of the best selling profiles for carpet and vinyl floorcoverings.

the Zenith profile range

Beautifully finished profiles for resilient floorcoverings, the extensive range includes the Stick & Go profiles, speeding up installations saving you time and money.

FlexiblePVC floor profiles

A range of quality PVC profiles in a variety of colours that can be laid straight or easily curved on site.





max Reflections

Give your room the ultimate makeover with **Max Reflections** from Floorwise to best co-ordinate with your other metallic fixtures and fittings and to give a seamless, designer look.

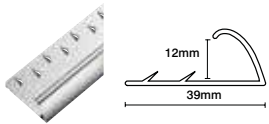
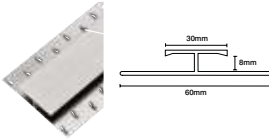
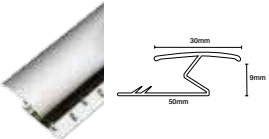
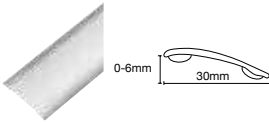
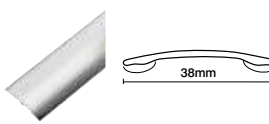
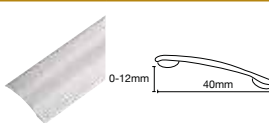
Packing - Box: 0.9m lengths x 15 = 13.5m Tube: 2.7m lengths x 5 = 13.5m

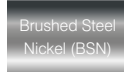
Product	Dimensions	Finish (see key below)	Length (m)	Tube qty	Ref.
217 Single Edge (Carpet Edging Strip) 		C	2.7	5	217.9C
		BSN	0.9	15	217.3C
		BBK	2.7	5	217.9BSN
		BSG	0.9	15	217.3BSN
235 Dual edge (carpet to carpet) 		C	2.7	5	235.9C
		BSN	0.9	15	235.3C
		BBK	2.7	5	235.9BSN
		BSG	0.9	15	235.3BSN
248 Z Edge - adjustable up to 9mm (carpet to wood/ laminates/ceramics) 		C	2.7	5	248.9C
		BSN	0.9	15	248.3C
		BBK	2.7	5	248.9BSN
		BSG	0.9	15	248.3BSN
251 2-in-1Stick Down Ramp Edge/Cover Strip 0-6mm 		C	2.7	5	251.9C
		BSN	0.9	15	251.3C
		BBK	2.7	5	251.9BSN
		BSG	0.9	15	251.3BSN
252 Stick Down Cover Strip 38mm (universal) 		C	2.7	5	252.9C
		BSN	0.9	15	252.3C
		BBK	2.7	5	252.9BSN
		BSG	0.9	15	252.3BSN
253 2-in-1Stick Down Ramp Edge/Cover Strip 0-12mm 		C	2.7	5	253.9C
		BSN	0.9	15	253.3C
		BBK	2.7	5	253.9BSN
		BSG	0.9	15	253.3BSN

Finish key				
------------	---	---	---	---

For prices contact your nearest distributor – see back cover



Premium heavy-duty metals mark out the **Max range** to bring complete peace of mind in domestic and commercial applications. Where strength and rigidity are key, make sure it's the Max – for profiles that will stand the test of time!

Packing - - Tube: 15 x 2.7m lengths = 40.5m Tube: 9 x 2.7m lengths = 24.3m

Product	Dimensions	Finish	Length (m)	Tube qty	Ref.
214 Single Edge Raised Base - Super Max Duty		Polished Aluminium	2.7	15	214.9A
		Simbrass	2.7	15	214.9S
223 Dual edge - Super Max Duty		Polished Aluminium	2.7	9	223.9A
		Simbrass	2.7	9	223.9S
224 Dual edge Raised Base - Super Max Duty		Polished Aluminium	2.7	9	224.9A
		Simbrass	2.7	9	224.9S
236 Extra Wide Cover Strip (universal)		Polished Aluminium	2.7	15	236.9A
		Simbrass	2.7	15	236.9S



Order your Floorwise Profiles brochure today. See back cover for your nearest distributor.



Floorwise provide a wide range of high-quality display stands, product samples and other support materials for all of our products.

These have all been professionally designed and produced to help the flooring professional demonstrate our products to their customers.

Please contact us to request any of our promotional display items and to discuss how we can help you upsell across the entire Floorwise range.

the **Classic** profile range

The **Classic Range** is precision-engineered to exacting standards. With more metal for your money, Floorwise premium quality profiles are durable, easier to handle, and finished to perfection.

Product	Dimensions	Finish	Length (m)	Tube qty	Ref.
211 Single Edge		Polished aluminium	0.9	45	211.3A
		Polished aluminium	2.7	15	211.9A
		Simbrass	0.9	45	211.3S
		Simbrass	2.7	15	211.9S
213 Single Edge Unpunched		Polished aluminium	2.7	15	213.9A
		Simbrass	2.7	15	213.9S
220 Dual edge		Polished aluminium	0.9	45	220.3A
		Polished aluminium	2.7	15	220.9A
		Simbrass	0.9	45	220.3S
		Simbrass	2.7	15	220.9S
230 Carpet cover strip 37mm		Polished aluminium	0.9	45	230.3A
		Polished aluminium	2.7	15	230.9A
		Simbrass	0.9	45	230.3S
231 Cover Strip 25mm		Polished aluminium	2.7	15	231.9S
		Polished aluminium	0.9	45	232.3A
		Polished aluminium	2.7	15	232.9A
232 Cover Strip 37mm		Polished aluminium	0.9	45	232.3A
		Polished aluminium	2.7	15	232.9A
		Simbrass	0.9	45	232.3S
		Simbrass	2.7	15	232.9S
233 Lino Edge small 4mm		Polished aluminium	0.9	45	233.3A
		Polished aluminium	2.7	15	233.9A
		Simbrass	2.7	15	233.9S

For prices contact your nearest distributor – see back cover



Packing - Box: 45 x 0.9m lengths = 40.5m

Tube: 15 x 2.7m lengths = 40.5m

Other lengths may be available upon request



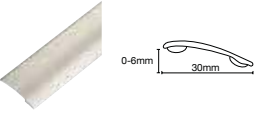
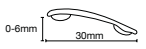
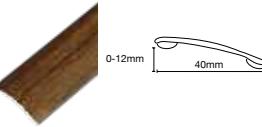

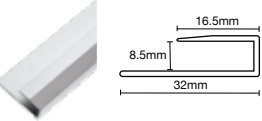
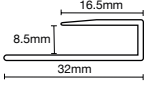
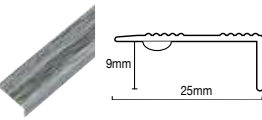
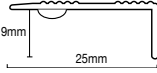
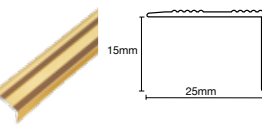
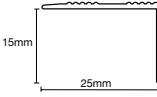
Product	Dimensions	Finish	Length (m)	Tube qty	Ref.
234 Lino Edge medium 6mm		Polished aluminium	0.9	45	234.3A
		Polished aluminium	2.7	15	234.9A
		Simbrass	2.7	15	234.9S
		Simbrass	2.7	15	234.9S
240 Square Edge Raised Base		Polished aluminium	2.7	15	240.9A
		Simbrass	2.7	15	240.9S
241 Angle/Mat Edge 23mm		Polished aluminium	2.7	15	241.9A
		Polished aluminium	2.7	15	241.9A
242 Stair/Matwell Edge 42mm		Polished aluminium	2.7	15	242.9A
		Polished aluminium	2.7	15	242.9A
243 Carpet Tile Edge Unpunched		Polished aluminium	2.7	15	243.9A
		Polished aluminium	2.7	15	243.9A
245 Z Edge, adjustable height up to 9mm		Polished Aluminium	0.9	45	245.3A
		Polished Aluminium	2.7	15	245.9A
		Simbrass	0.9	45	245.3S
		Simbrass	2.7	15	245.9S
246 Z Edge, adjustable height up to 14mm		Polished Aluminium	2.7	15	246.9A
		Simbrass	2.7	15	246.9S

The **Zenith Stick Down Range** makes it easy to find the ideal match to Wood, Laminate & LVT flooring, delivering a neat, attractive and robust finish. The Stick Down range is a must for the professional fitter, cutting down installation time by up to 80% against slower drill and fix methods.

Product	Dimensions	Finish	Length (m)	Tube qty	Ref.
251 Stick Down Ramp Edge/ Cover Strip 0-6mm 		BSNA	2.7	5	251.9BSNA
		CA	2.7	5	251.9CA
		OAA	2.7	5	251.9OAA
		DKWA	2.7	5	251.9DKWA
		GOA	2.7	5	251.9GOA
		BKA	2.7	5	251.9BKA
253 Stick Down Ramp Edge/ Cover Strip 0-12mm 		BSNA	2.7	5	253.9BSNA
		CA	2.7	5	253.9CA
		OAA	2.7	5	253.9OAA
		DKWA	2.7	5	253.9DKWA
		GOA	2.7	5	251.9GOA
		BKA	2.7	5	253.9BKA
277 Square Edge 8mm 		MS	2.7	10	277.9MS
		MG	2.7	10	277.9MG
287 Stick Down Ramp Edge/ Cover Strip 0-6mm 		OAA	2.7	5	287.9OAA
		DKWA	2.7	5	287.9DKWA
		GOA	2.7	5	287.9GOA
		BKA	2.7	5	287.9BKA
		SGA	2.7	5	287.9SGA
		MS	2.7	5	287.9GMS
288 Stick Down Edge 15mm 		SGA	2.7	10	288.9SGA
		MGA	2.7	10	288.9MGA
		MSA	2.7	10	288.9MSA

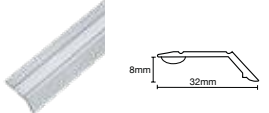
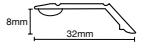
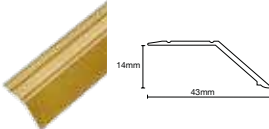
Packing - Tube: 5 x 2.7m lengths = 13.5m (251 & 253)
 Tube: 10 x 2.7m lengths = 27m (277 & 287)
 Tube: 15 x 2.7m lengths = 40.5m (245 only)

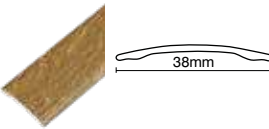
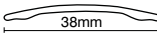
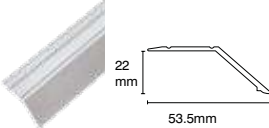
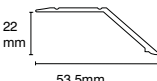
Other lengths may be available upon request

Product	Dimensions	Finish	Length (m)	Tube qty	Ref.	
289 Stick Down Sloping Edge 8mm 		SGA	2.7	10	289.9SGA	
		MGA	2.7	10	289.9MGA	
		MSA	2.7	10	289.9MSA	
290 Stick Down Sloping Edge 14mm 		SGA	2.7	10	290.9SGA	
		MGA	2.7	10	290.9MG	
		MSA	2.7	10	290.9MS	
291 Stick Down Cover Strip 38mm 		MOAA	2.7	10	291.9MOAA	
		GOA	2.7	10	291.9GOA	
		DKWA	2.7	10	291.9DKWA	
		MGA	2.7	10	291.9MGA	
		MSA	2.7	10	291.9MSA	
292 Stick Down Sloping Edge 22mm 		SGA	2.7	10	292.9SGA	
		MGA	2.7	10	292.9MGA	
		MSA	2.7	10	292.9MSA	
Metal finishes 	Chrome (CA)	Brushed Steel Nickel (BSNA)	Black (BKA)	Space Grey (SGA)	Matt Gold (MGA)	Matt Silver (MSA)
	Wood finishes 	Grey Oak (GOA)	Oak (OAA)	Walnut (DKWA)		

For prices contact your nearest distributor – see back cover

Flexible PVC floor profiles

Curvable PVC Floor trims

A range of **Flexible PVC** transition profiles in a variety of colours that can be laid straight or easily curved on site.

Product	Dimensions	Finish	Length (m)	Tube qty	Ref.
8775 Multiple height combination flat transition		see page 52-53	2.75	10	8775---
8780 Multiple height combination ramped transition		see page 52-53	2.75	10	8780---
8785 Multiple height combination ramped transition		see page 52-53	2.75	10	8785---
8790 Multiple height combination ramped transition		see page 52-53	2.75	5	8790---
87P1 Base channel 8.5mm		-	2.75	10	87P1
87P2 Base channel 16mm		-	2.75	10	87P2
87P3 Base channel 6mm		-	2.75	10	87P1
87P4 Base channel 12mm		-	2.75	10	87P1
87A2 Base channel 12mm		Punched	2.75	10	87A2P
		Unpunched	2.75	10	87A2U
87A1 Base channel 6mm		-	2.75	10	87A1

Floor level combinations

Combinations of tops and bases and the heights of floorcoverings they connect

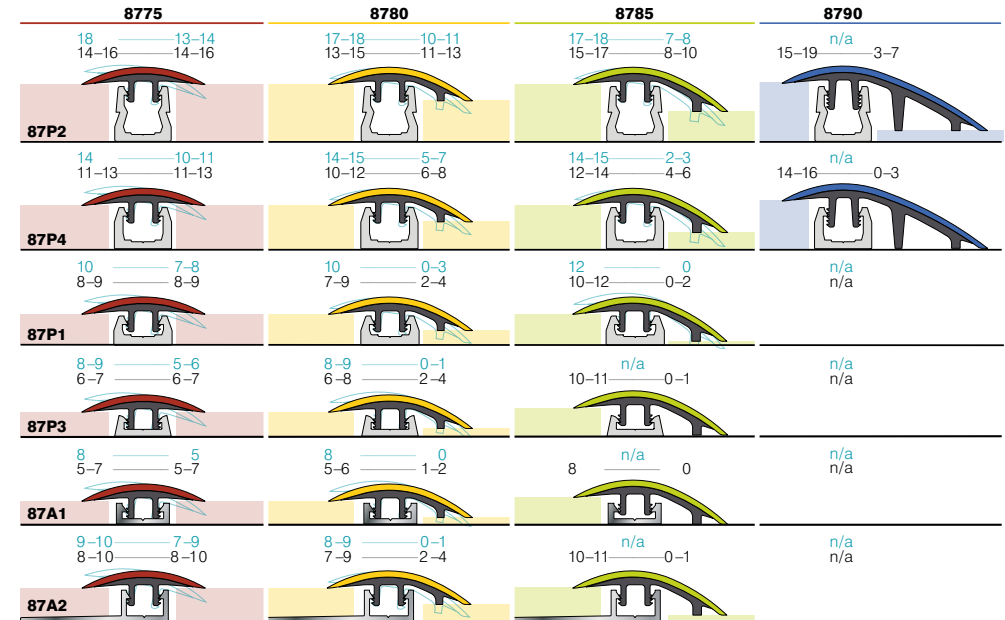

Colours

The product code for ordering Curvable PVC Floor Trims is made up of the relevant part number above (Ref.) and the 3-letter colour code shown on **pages 70-71**.

For example, the code for an 8780 Curvable PVC Floor Trim in Royal Blue would be 8780ROY.



For prices contact your nearest distributor – see back cover

Stair Nosings, Skirtings and Trims

Aluminium Stair Nosings	63
Q-Range	64
Aluminium and PVC Stair Edge Trims and Angles	66
Floormitre Cap and Cove Systems	66
Flexible Bevels, Ramps, Profiles and Joints	67
PVC Skirtings	68
Nosings, Trims and Skirtings colour chart	70

Stairs are an inherently dangerous part of any building presenting both a trip and a fall hazard, so don't skimp when it comes to safety.

Floorwise offer a range of nosings with flat, raked or bullnose profiles to suit almost any stair application and floorcovering along with a selection of edge trims and angles to help you get the perfect finishing detail.

We also offer a wide range of colour options as well as a selection of standard tread or supergrip inserts to suit your specific application.



Aluminium Stair Nosings

Standard gauge

Standard gauge aluminium stair nosings best suited for floorcoverings with a thickness of 2mm–3.5mm.

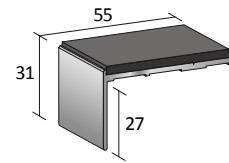

SF11 - single channel flat

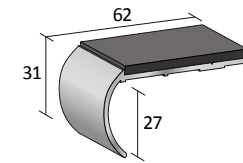

SF31 - single channel bullnose

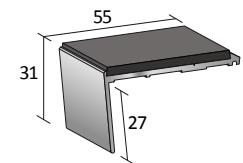

SF51 - single channel raked

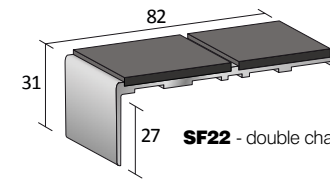

SF22 - double channel flat

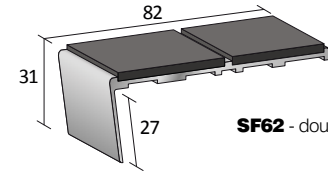

SF62 - double channel rake

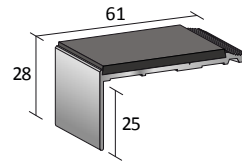

SF141 - single channel flat - ramp back

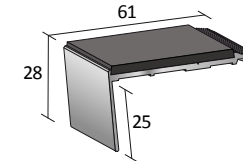

SF151 - single channel raked - ramp back

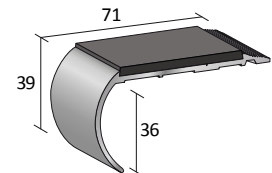

SF161 - single channel bullnose - ramp back

Heavy duty gauge

Heavy duty gauge aluminium stair nosings best suited for floorcoverings with a thickness of 4mm–7mm.

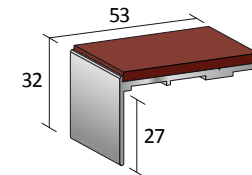

HF11 - single channel flat

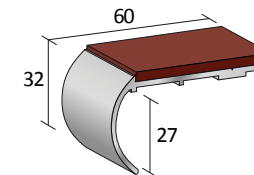

HF31 - single channel bullnose

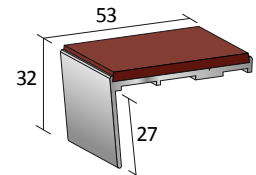

HF51 - single channel raked

- Stock lengths: 2.44m, 2.75m and 3.2m
- Pre-packed (secret fixing): 20 lengths x 1.22m
- Also available cut to size, drilled & undrilled

- Brightened Finish
- Super Chrome Finish

Colours

The product code for ordering Stair Nosings is made up of the relevant part number above and the 3-letter colour code shown on page on page 52. The code for a SF11 Single Channel nosing in Poppy would therefore be SF11POP.

Drawings not to scale.

Q-Range

Slenderline gauge

Stair nosings best suited for floorcoverings with a thickness of 0mm–3.5mm

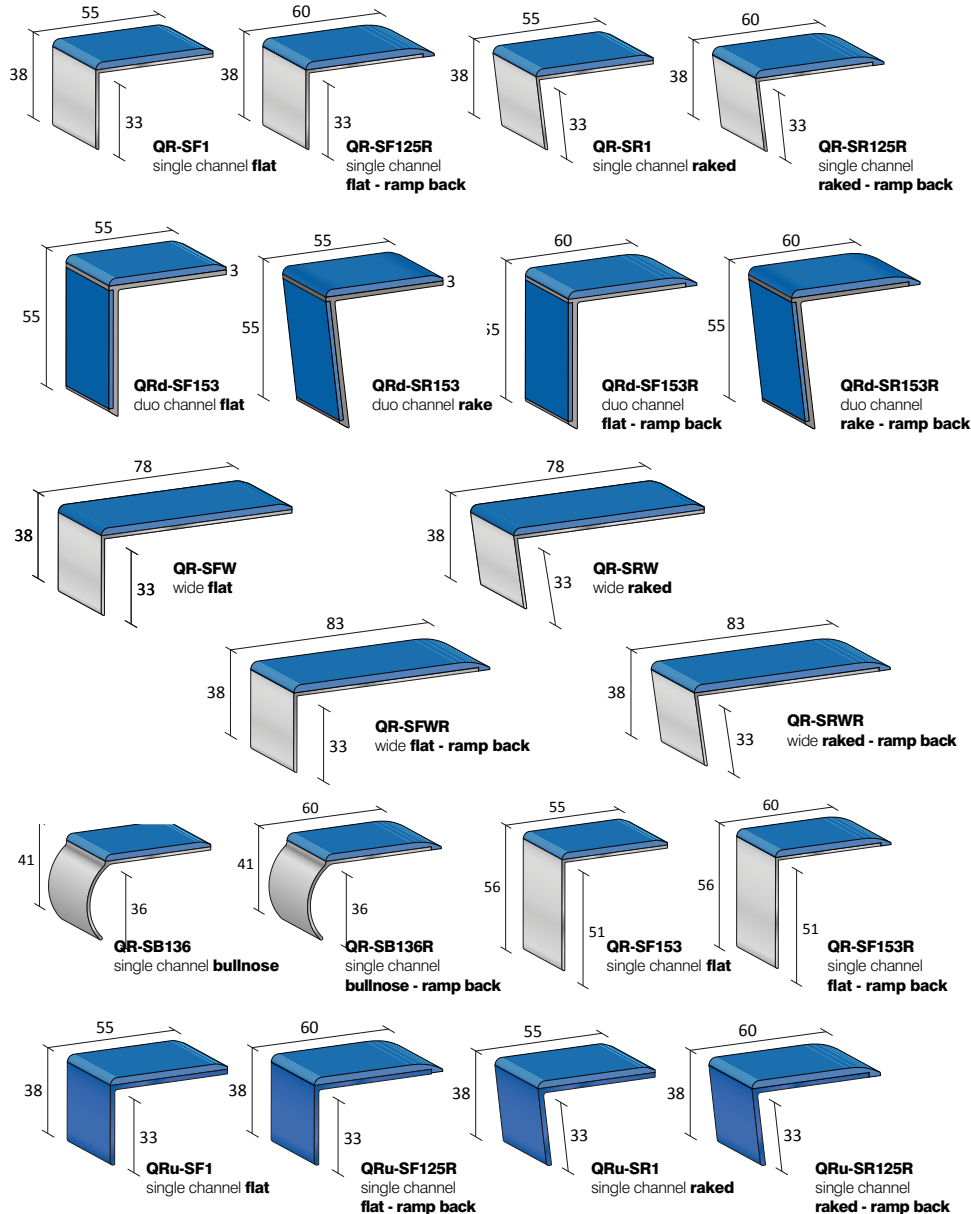

Heavy duty gauge

Stair nosings best suited for floorcoverings with a thickness of 4-7mm

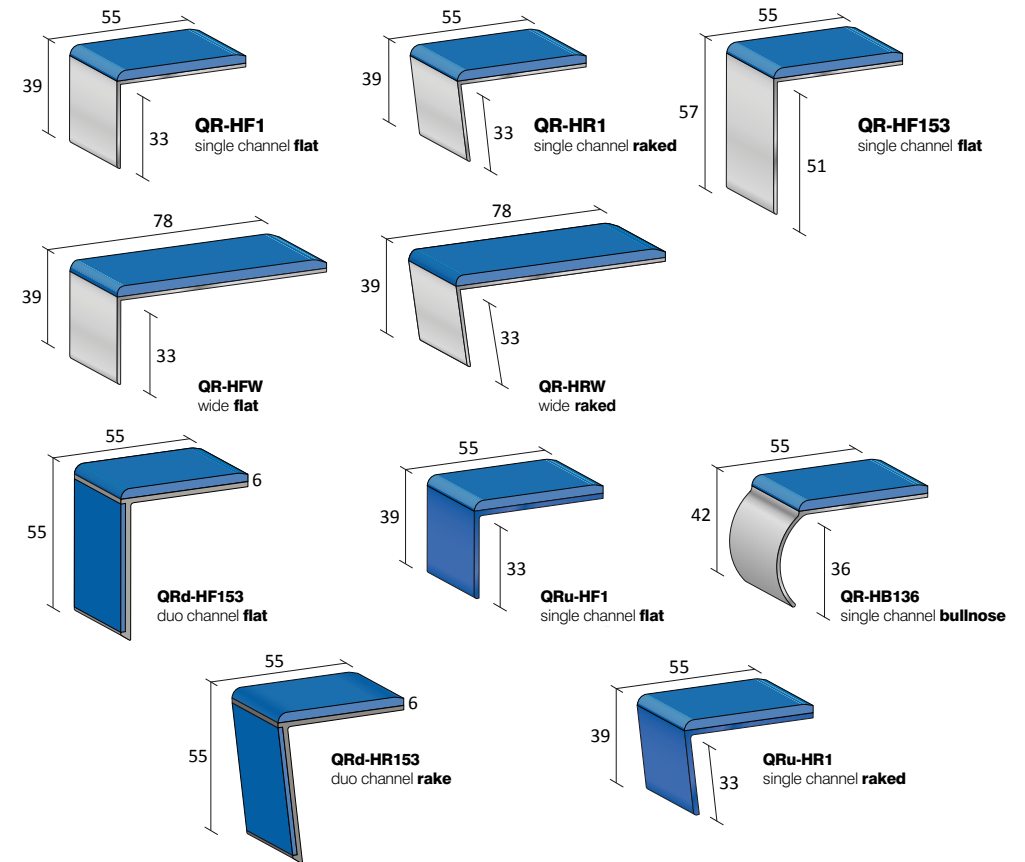

Building regulations best practice

All Q-Range stair nosings (except bullnose) offer a Building Regulations best practice solution in PVCu or when specified with polar grey tread material.

NOTE: There should be 30 points of difference in the LRV value between the floor covering and the stair nosing.

- Stock lengths: 2.44m, 2.75m and 3.2m
- Pre-packed (secret fixing): 20 lengths x 1.22m
- Also available cut to size, drilled & undrilled

- Brightened Finish
- Super Chrome Finish

Colours

The product code for ordering Stair Nosings is made up of the relevant part number above and the 3-letter colour code shown on page 52. The code for a QR-HF1 Single Channel nosing with Yellow Tread would therefore be QR-HF1YEL.

Drawings not to scale.

Aluminium and PVC Stair Edge Trims and Angles

Pre-formed universal angles for finishing step sides on open string staircases.
Special shapes, bespoke to project are available on request and subject to lead times.

A610
Aluminium 83° pre-formed Angles

A620
Aluminium 90° pre-formed Angles

A600
Aluminium stock length 2.75m

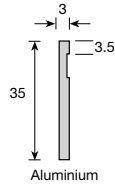

P610
PVCu 83° pre-formed Angles

P620
PVCu 90° pre-formed Angles

P600
PVCu stock length 2.75m

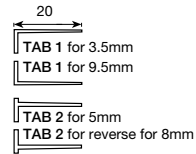
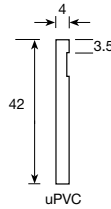

- Brightened Finish
- Super Chrome Finish

- **Universal tabs** are included with package to cover all heights.
- **Pre-formed:** 83° or 90°, 360mm x 360mm, singles or boxed in 20s.
- **Stock lengths:** 2.75m complete with joints and tabs to make up on site.

Floormitre Cap and Cove System

Internal and external floormitres

Designed to make the fitting of vinyl around corners easier, quicker and smoother.

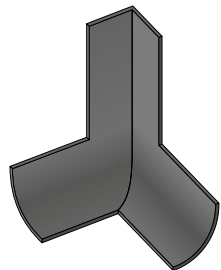

CCFM1
Internal Floormitre
50 per box

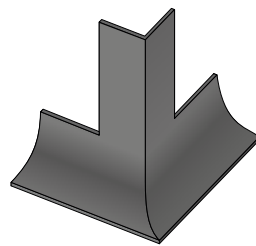

CCFM2
External Floormitre
50 per box

Flexible Bevels, Ramps, Profiles and Joints

Bevel strips and ramp edges

Flexible finishing strips and ramps for floorcovering edges. Can be easily curved on site.

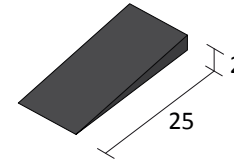

8751
25 x 2mm
5m coils
5 per box

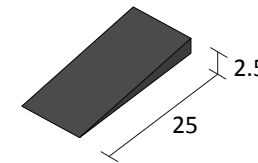

8752
25 x 2.5mm
5m coils
5 per box

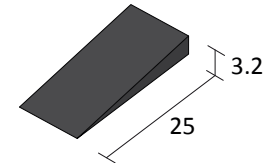

8753
25 x 3.2mm
25m coils
5 per box

8754
33 x 4.5mm
2m lengths
50 per box

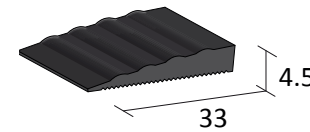

8755
38 x 6.0mm
2m lengths
50 per box

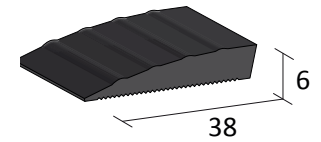

Flexible flooring profiles

Finishing profiles for joints between floor coverings. Can be easily curved on site.

8770 Dual Edge
35 x 5mm/9mm
2m lengths
25 per box

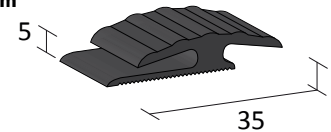

8772 Ramp Edge
40 x 5mm
2m lengths
25 per box

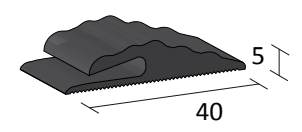

Expansion joints

Finishing profiles for joints between floor coverings. Can be easily curved on site.

QCJ50
50 x 2.5mm
15m coils
3 per box

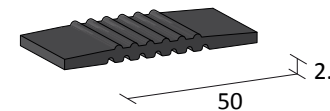

QCJ75
75 x 2.5mm
15m coils
2 per box

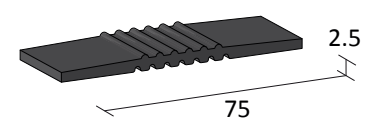

Colours

The product code for ordering Flexible Bevels, Ramps, Profiles and Joints is made up of the relevant part number above and the 3-letter colour code shown on page on page 52. The code for a 8770 Dual Edge profile in Charcoal would therefore be 8770CHA.

Drawings not to scale.

PVC Skirtings

Sit-on skirting

Easy to fit standard skirting finish for vinyl floors.

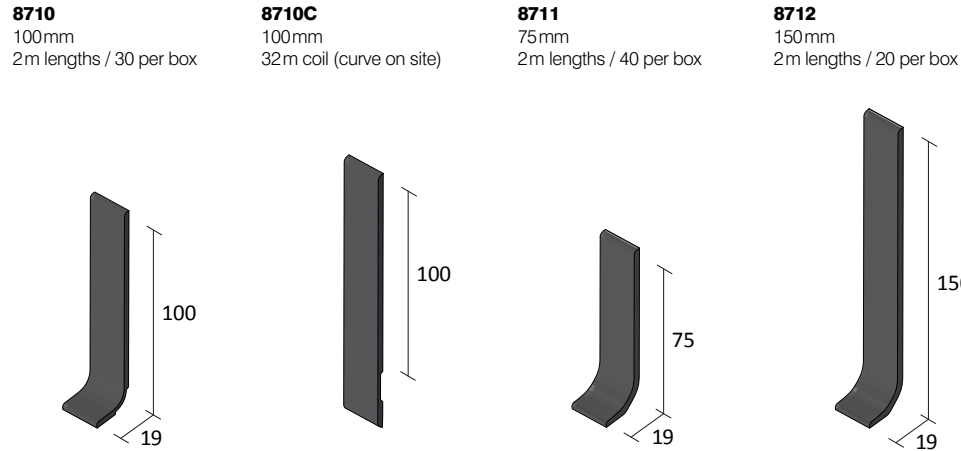

Set-in skirting

Skirtings with welded foot for seamless and hygienic finish with vinyl floors in hospitals, schools and wet areas (e.g. bathrooms).

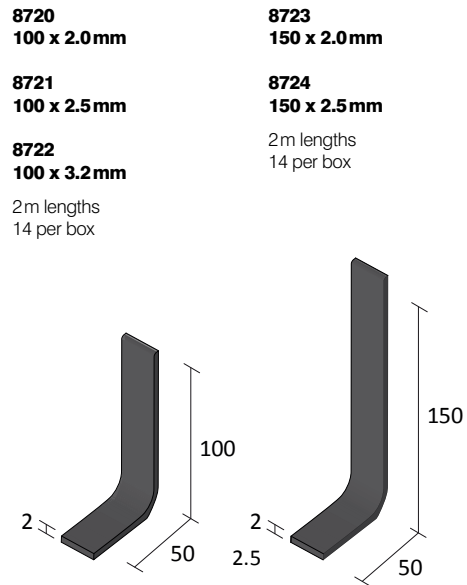

Flat skirting

Protective edge to wall and door bases. Use with vinyl floors or carpet tiles.

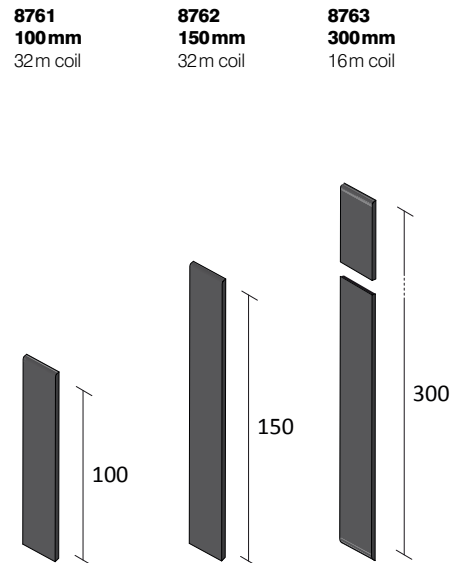

Capping strips

Finishing caps for floor coverings when material is formed up the wall base.

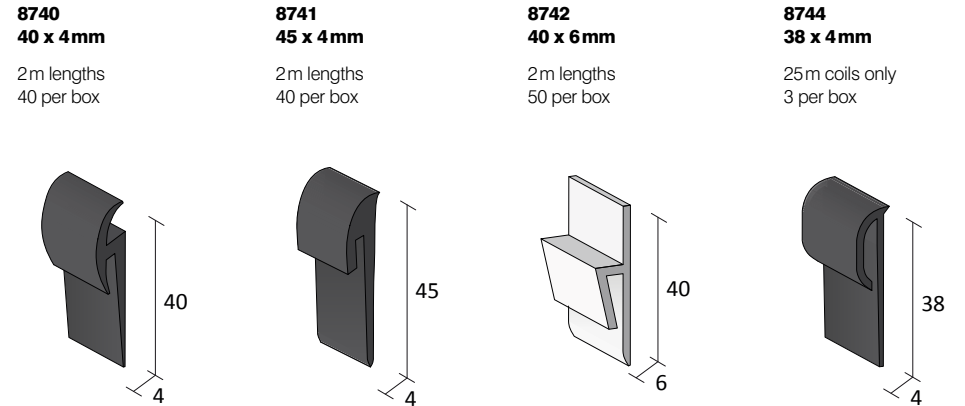

Cove formers

Preformed cove support for vinyl or linoleum flooring to curve up the wall base from the floor edge.

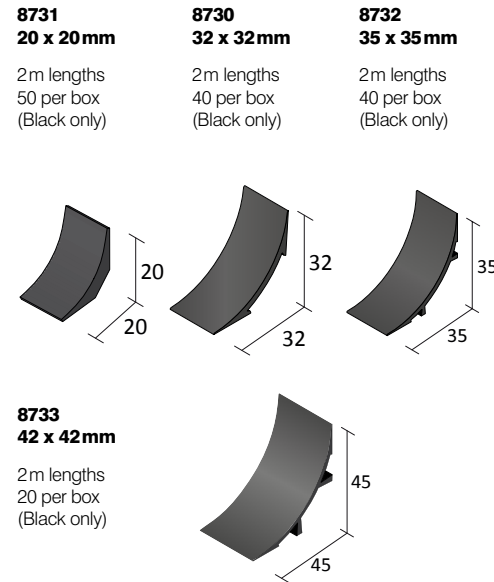

Combined cove former and capping strip

This combined, preformed cove former and capping strip is a valuable time saver on site.

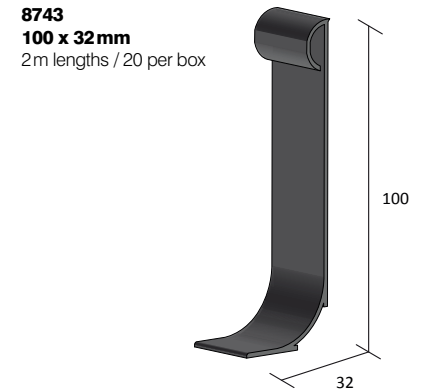

Colours

The product code for ordering Capping Strips is made up of the relevant part number above and the 3-letter colour code shown on page on page 53. The code for a 8740 Capping Strip in Dark Brown would therefore be 8740DBR.

Drawings not to scale.

Stair Nosings, Skirting and Trims Colour Chart

✓* Minimum quantities may apply

Code	Colour	LRV	Stair Nosings			Stair Edge Trims and Angles	PVCu Skirting	Coves and Capping Strips	Bevels and Ramps	Curvable PVC Floor Trims
			Standard Tread	Super Grip (Not in Q-Range)	PVCu Channel					
CAR	Carbon	5		✓						
CLA	Claret	6	✓		✓	✓			✓*	
BLK	Black	6	✓		✓	✓	✓	✓	✓*	
DBR	Dark Brown	9				✓	✓	✓*		
RUB	Ruby	9		✓						
RUS	Rustic	10	✓		✓	✓			✓*	
PEA	Peat	10	✓		✓	✓			✓*	
GRA	Granite	11	✓		✓	✓	✓		✓*	
BLU	Dark Blue	11	✓		✓	✓			✓*	
REG	Regency	11	✓		✓	✓			✓*	
SPR	Spruce	11	✓		✓	✓			✓*	
POP	Poppy	13	✓						✓*	
CHA	Charcoal	15				✓	✓	✓*		
FLI	Flint	15	✓		✓	✓			✓*	
ROY	Royal Blue	16	✓						✓*	
FAW	Fawn	21	✓						✓*	
AQA	Aqua	22		✓						
BOU	Boulder	25				✓				
LIG	Light Grey	26	✓		✓	✓			✓*	
PLA	Platinum	27		✓						
CLG	Cloud Grey	26				✓	✓	✓		
JAD	Jade	30	✓						✓*	
CAR	Caramel	31				✓	✓			
TAN	Tangerine	33	✓						✓*	
SAN	Sand	41		✓						
HOR	Hornet	47		✓						
PLR	Polar Grey	49	✓		✓	✓			✓*	
IVO	Ivory	51	✓		✓	✓			✓*	
SKY	Sky	52	✓						✓*	
LIM	Lime	53	✓						✓*	
SUN	Sun	56	✓						✓*	
YEL	Yellow	67	✓		✓	✓			✓*	
PHO	Photoluminescent	69	✓							
WHT	White	81	✓		✓	✓	✓	✓*	✓*	

Tools and Sundries

Cutting	73
Carpet Fitting	74
Measuring and Scribing	77
Surface Preparation	79
Wood and Laminate Floor Laying	80
PVC/Lino Laying	81
Workwear and Protection	82
Storage and Handling	82

Choosing the right tools for the job has never been easier!

Floorwise sells a selection of the world's best tools for carpet installers. Our range has been carefully selected to provide the ultimate in functionality, practicality and long-lasting product quality. This means that we are confident that tools from the Floorwise range will provide the maximum assistance for professional floor fitters seeking a quality installation.





Tools and Sundries

Product Type	FWG Ref	Description	Quantity	Colour
Cutting tools Knives 	F7510		1	Chrome
	F7510B		1	Blue
	F7510BK		1	Black
	F7510W	Dolphin Knife with Holster	1	White
	F7510G		1	Green
	F7510Y		1	Yellow
	F7510R		1	Red
	F7515	Professional Linoleum Tucking Knife	1	
F7514	Dolphin Knife 2000 with Holster	1	Chrome	
Cutting tools Blades 	F7544	Hooked + Pointed Blades	20 x 5 = 100	-
	F7546	Heavy Duty Blades	20 x 5 = 100	-
	F7547	Medium Duty Blades	20 x 5 = 100	-
	F7551B	Blades	12 Pack	-
	F7548	Hooked Blades	20 x 5 = 100	-
	F7549	Concave Blades	20 x 5 = 100	-
	F7545	Super Hooked Blades	20 x 5 = 100	-
	F7550B	Razor Style Blades	20 x 5 = 100	-
	F7554B	Slotted Blades	20 x 5 = 100	-
	F7214B	Scraper Blades	10 x 10 = 100	-
F7216B	Scraper Blades	10 x 10 = 100	-	
Cutting tools Shears 	F7520	12" Professional Knife Edge Shears	1	-
	F7521	10" Professional Knife Edge Shears	1	-
	F7524	7" Stainless Steel Napping Shears 2 finger	1	-
	F7524-7	Professional Napping Shears 3 Finger	1	-
	F7525	Super Gripper Shears	1	-
	F7525A	Spare Anvil	1	-
	F7525B	Spare Blade	1	-
	F7527	Mitre Shears	1	-
	F7527A	Spare Anvil	1	-
	F7527B	Spare Blade	1	-
F7528	Aviation Snips	1	-	

For prices contact your nearest distributor – see back cover

Tools and Sundries

Product Type	FWG Ref	Description	Quantity	Colour
Cutting tools Shears continued 	F7550	Combi Carpet Trimmer	1	-
	F7550B	Razor Style Blades	100	-
	F7551	Crain Deluxe Carpet Trimmer	1	-
	F7551B	Crain Carpet Trimmer Blades	12	-
	F7552	Araseur Carpet & Vinyl Trimmer	1	-
	F7552B	Araseur Hooked Blades	20 x 5 = 100	-
	F7553	High Tech Cutter	1	-
	F7553B	High Tech Cutter - Hooked Blades	20 x 5 = 100	-
	F7560	Hacksaw	1	-
	F7560B	Hacksaw Blades	10	-
Knee kickers 	F7006	Roberts GT Knee Kicker	1	-
	F7002	Crain Deluxe Knee Kicker	1	-
	F7010	Crain Swivel Lock Power Stretcher	1	-
	F7010E	Crain Spare Tube	1	-
Heat seaming irons 	F7014	Roberts Deluxe Heatbond Carpet Seaming Iron	1	-
	F7015	F7015 110V Crain Grooved Deluxe Heat 1 Seaming Iron 110V	1	-
	F7015	F7015 110V Crain Grooved Deluxe Heat 1 Seaming Iron 220V	1	-
	F7015C	Carrying Case	1	-
	F7020	Straight Axle Seam Roller	1	-
	F7020F	Flexible Axle Seam Roller	1	-
	F7021W	7.5kg Seam Weight	1	-
	F7021	Carpet Seam Clamp	1	-

For prices contact your nearest distributor – see back cover

Tools and Sundries



Product Type	FWG Ref	Description	Quantity	Colour	
Tack hammers 	F7022	Magnetic Tack Hammer	1	-	
	F7023	Super Tack Hammer	1	-	
	F7024	Claw Hammer	1	-	
	F7025A	Magnetic Driving Bar	1	-	
	F7027	Stair Tool 3.5"	1	-	
	F7028	Tack & Moulding Lifter	1	-	
	F7029	Carpet Awl	1	-	
	F7031	Bent Stair Tool 3.5"	1	-	
	F7034	Speedcatt Tucking Tool	1	-	
	F7035	Row Separator	1	-	
	Nails   	F7700	19mm Concrete Nails	500g	-
		F7701	25mm Concrete Nails	500g	-
		F7712	15mm Concrete Nails	500g	-
F7713		32mm Concrete Nails	500g	-	
F7730		15mm Concrete Nails	1kg	-	
F7731		19mm Concrete Nails	1kg	-	
F7732		25mm Concrete Nails	1kg	-	
F7733		32mm Concrete Nails	1kg	-	
F7710		20mm Ring Shank Nails	500g	-	
F7711		25mm Ring Shank Nails	500g	-	
F7714		30mm Ring Shank Nails	500g	-	
F7720		20mm Ring Shank Nails	1kg	-	
F7721		25mm Ring Shank Nails	1kg	-	
F7722		30mm Ring Shank Nails	1kg	-	
F7770		25mm Zinc Plated Slotted Screws	500g	-	
F7770S		25mm Simbrass Slotted Screws	500g	-	
F7764		20mm Gimp Pins	500g	-	
F7045Y	5/5.5mm Yellow Rawl Plugs	1000	Yellow		
F7045R	5.5/6mm Red Rawl Plugs	1000	Red		
F7763	25mm Blued Tacks	500g	-		
F7763A	25mm Blued Tacks	1kg	-		
F7768	16mm Cork Pins	500g	-		

Tools and Sundries

Product Type	FWG Ref	Description	Quantity	Colour
Masonry drill bits 	F7040	4mm Masonry Drill Bit	10	
	F7041	5mm Masonry Drill Bit	10	
	F7042	5.5mm Masonry Drill Bit	10	
	F7043	5mm SDS Masonry Drill Bit	10	
	F7044	5.5mm SDS Masonry Drill Bit	10	
Stapling guns and staples  	F7049	Tacwise 191ELS Combination Stapler & Nailer Tool	1	-
	F7050	Maestri ME4000 Stapling Machine	1	-
	F7050/16	16mm Bronzed Staples for Hardboard	10,000	-
	F7050/20	20mm Bronzed Staples for Plywood	10,000	-
	F7051	Maestri ME606 Electronic Staple & Brad Machine	1	-
	F7051/18	18mm Silver Staples for ME606	4,800	-
	F7051/22	22mm Silver Staples for ME606	4,800	-
	F7051/TG15	15mm Brad/Pins	8,000	-
	F7051/TG19	19mm Brad/Pins	7,000	-
	F7051/TG25	25mm Brad/Pins	5,000	-
	F7061	Hammer Tacker	1	-
	F7064	Staple Remover	1	-
	F7063	Rapid Staple Gun	1	-
	F7063/10	10mm Rapid Staples	5,000	-
	F7063/14	14mm Rapid Staples	5,000	-
	F7065	Tacwise A54 Heavy Duty Hammer Tacker	1	-
	F7061/8	8mm Staples	5,000	-
F7061/9	9mm Staples	5,000	-	
F7061/10	10mm Staples	5,000	-	

For prices contact your nearest distributor – see back cover



Tools and Sundries

Product Type	FWG Ref	Description	Quantity	Colour
Hot melt guns 	F7894	Heavy Duty Industrial Hot Melt Adhesive Gun	1	-
	F7891/12	Industrial Hot Melt Adhesive Gun	1	-
	F7882	Carrying Case for All Guns	1	-
	F7893/12	Cordless Industrial Hot Melt Adhesive Gun	1	-
	F7890	Badaptor	1	-
	F7990H	Tackfix 180 Glue Sticks for Hardwood	20	-
	F7990C	Tackfix 48 Glue Sticks for Concrete	20	-
	F560	43mm Hot Melt Glue Slugs	85	-
F565	12mm Hot Melt Glue Sticks	160	-	
Measuring and scribing equipment 	F7300	Chalk Line Reel	1	-
	F7301	Chalk Line Refill	8oz	White
	F7302	Chalk Line Refill	8oz	Blue
	F7303	Chalk Line Refill	8oz	Red
	F7335	5m Measuring Tape	1	-
	F7338	8m Measuring Tape	1	-
	F7340	Metre Measuring Stick	1	-
	F7350	Leica Laser Measure with Bluetooth	1	-
	F7120	Bar Scriber	1	-
	F7120P	Spare Pins	1	-
F7121	Recess Scriber	1	-	
F7121P	Spare Pins	1	-	



Order your Floorwise Tools brochure today.
Contact us on **01892 814922**



Tools and Sundries

Product Type	FWG Ref	Description	Quantity	Colour	
Straight edges and scribes 	F7304	2m Flexible Straight Edge	1	-	
	F7305	4m Flexible Straight Edge	1	-	
	F7306	Adjustable Straight Edge	1	-	
	F7307	2m Non-Slip Flexible Straight Edge	1	-	
	F7308	4m Non-Slip Flexible Straight Edge	1	-	
	F7535	Invisiseamer	1	-	
	F7535D	6' Extension	1	-	
	F7535E	12' Extension	1	-	
	F7122	Parajito Combination Scriber & Cutter	1	-	
	F7122P	Spare Pins	25	-	
	F7122B	Spare Blades	5	-	
	F7123	Parajito Scriber	1	-	
	F7123P	Spare Pins	25	-	
	F7124	8" Dividers	1	-	
	F7516	Crain Nickel Plated Mitre Box	1	-	
	Strippers and Scrapers 	F7210/110	Power Stripper 110V	1	-
		F7210/240	Power Stripper 240v	1	-
F7210B		60mm Spare Blade	1	-	
F7210LB		130mm Spare Blade	1	-	
F7210TW		Transport Wheels	1	-	
F7210T		T-Handle	1	-	
F7210C		Carrying Case	1	-	
F7214/18		18" Deluxe Hand Scraper	1	-	
F7214/12		12" Deluxe Hand Scraper	1	-	
F7214B		Scraper Blades	10x10= 100	-	
F7219		Carpet Claw	1	-	
F7216/18		Crain Steel Handled Scraper	1	-	
F7216B		Scraper Blades	10x10= 100	-	
F7213		Hit Scraper	1	-	
F7213B		Reversible Spare Blade	1	-	
F7218		Parajito Long-Handled Scraper	1	-	
F7218B		Spare Blade	1	-	

Tools and Sundries

Product Type	FWG Ref	Description	Quantity	Colour
Mixers and rollers 	F7222/110	Vitrex 850w Mixing Drill – 110V	1	-
	F7222/230	Vitrex 850w Mixing Drill – 230V	1	-
	F7225	Mixing Drill Whisk	1	-
	F7230/50	50cm Spiked Aeration Roller	1	-
	F7230/25	25cm Spiked Aeration Roller	1	-
	F7223/14	14l Gorilla Mixing Tub	1	-
	F7223/26	26l Gorilla Mixing Tub	1	-
	F7223/42	42l Gorilla Mixing Tub	1	-
	F7226	Mixing Drill Whisk	1	-
	F7225P	Parajito Drill Whisk	1	-
	F7230T	Telescopic Extension Pole	1	-
	F7238	12" Double Arm Frame for Primer Roller	1	-
	F7238R	12" Primer Roller	1	-
	F7221	Professional Stirring Station	1	-
Trowels 	F7227	Flemish Pointed Screeding Trowel 45x11cm	1	-
	F7228	Ragni Screeding Trowel 36x12cm	1	-
	F7229	Ragni Screeding Trowel 28x12cm	1	-
	F7257	3-piece Japanese Trowel Set	1	-
	F7240	Adhesive Trowel Pack 1mm x 4mm	1	-
	F7240B	Spare Blade 1mm x 4mm	1	-
	F7241	Adhesive Trowel Pack 1.5 x 5mm	1	-
	F7241B	Spare Blade 1.5 x 5mm	1	-
	F7242	Adhesive Trowel Pack 2mm x 6mm	1	-
	F7242B	Spare Blade 2mm x 6mm	1	-
	F7245-A1	18cm Adhesive Spreader – A1	1	-
	F7245-A2	18cm Adhesive Spreader – A2	1	-
	F7245-B1	18cm Adhesive Spreader – B1	1	-
	F7246-A1	25cm Adhesive Spreader – A1	1	-
	F7246-A2	25cm Adhesive Spreader – A2	1	-
F7246-B2	25cm Adhesive Spreader – B1	1	-	
F7239	Shoe In Spiked Soles 3 size options M (7-9) L(9-11), XL (11-12)	1	-	
F7237	Spiked Shoes	1	-	

Tools and Sundries

Product Type	FWG Ref	Description	Quantity	Colour
Applicators 	F7030	Cartridge Applicator Skeleton Gun	1	-
	F7032	Combination Sausage Gun	1	-
	F7234	Carborundum Grinding Stone	1	-
	F7250	Disposable Adhesive Syringes & Needles	1	-
	F7236	24" Screed Leveller	1	-
	F7251	Premium Gun for Spray Canisters	1	-
Wood and laminate floor laying equipment 	F7461	Straticut Laminate Guillotine	1	-
	F7415	Ratchet Straps & Clamps	1	-
	F7404	Power Shunter	1	-
	F7405	Professional Tapping Block – Flat	1	-
	F7406	55cm Professional Pulling/Impact Iron	1	-
	F7407	Rubber Mallet	1	-
	F7410	Crain Undercut Saw	1	-
	F7433/110	Professional Door Trimmer 110v	1	-
	F7433B	Spare TCT Blade	1	-
	F7052	Maestri Veneer Pinner	6100 (box)	-
	F7052/TG15	15mm brads/pins	6100 (box)	-
	F7052/TG20	20mm brads/pins	6100 (box)	-
	F7052/TG25	25mm brads/pins	6100 (box)	-
	F7052/TG30	30mm brads/pins	6100 (box)	-

Tools and Sundries

Product Type	FWG Ref	Description	Quantity	Colour
PVC/Lino laying equipment  	F7100/120	Grooving Machine – 120v	1	-
	F7100/230	Grooving Machine – 230v	1	-
	F7100B	130mm Grooving Blade	1	-
	F7100DB	130mm Diamond Grooving Blade	1	-
	F7153	Lino & PVC Strip Cutter	1	-
	F7154	LVT Hole Cutter	1	-
	F7155	Leister 'Groovy' Groover Tool	1	-
	F7101	LVT Design Cutter	1	-
	F7101B	Spare Blade	1	-
	F7105/110	Leister Triac ST Hot Air Welder – 110v	1	-
	F7105/220	Leister Triac ST Hot Air Welder – 220v	1	-
	F7106/110	Leister Triac ST Hot Air Welding Kit – 110v	1	-
	F7106/220	Leister Triac ST Hot Air Welding Kit – 220v	1	-
	F7108	Leister Standard Nozzle	1	-
	F7108S	Leister Speedweld Nozzle	1	-
	F7113	Router Handle	1	-
	F7113B	Router Blades	8	-
	F7150	PVC Edge Trimmer	6	-
	F7150B	Spare Blades	6	-
	F7152	Linocutter/Scraper	1	-
	F7136	Crain Steel Hand Roller	1	-
F7157	Pressing Hammer	1	-	
F7141/28	28kg Lino Roller	1	-	
F7141/50	50kg Lino Roller	1	-	
F7151	Mozart Trimmer	1	-	
F7151B	Spare Blades	5	-	
F7151P	Leather Pouch	1	-	
F7110	P Type Grooving Tool	1	-	
F7110B	U Shape Grooving Blades	10	-	
F7130	Spatula Trimming Knife	1	-	
F7130G	Spatula Guide	1	-	
F7130P	Leather Pouch	1	-	

Tools and Sundries

Product Type	FWG Ref	Description	Quantity	Colour
Workwear and protection 	F7800	Snickers Floorlaying Master Trousers	1	-
	F7810	Flexiwork Floorlayers Trousers	1	-
	F7856	Snickers Hoodie	1	-
	F7860	Snickers 37.5 Short Sleeve Polo Shirt	1	-
	F7865	Toe Guard Jumper Boots	1	-
	F7870	Snickers Beaded Knee Pads	1 (Pair)	-
	F7817	Fento 200 Pro Knee Protectors	1 (Pair)	-
	F7818	Medical Knee Pads	1 (Pair)	-
	F7805	Snickers D30 Craftsman Knee Pads	1 (Pair)	-
	F7815	Leather Knee Pads	1 (Pair)	-
	F7819	Super Soft Knee Pads	1 (Pair)	-
	F7819L	Super Soft Knee Pads - Leather	1 (Pair)	-
	Storage and handling 	F7960	24" Floorlayers Toolbag	1
F7955		30" Rope Handled Canvas Tool Bag	1	-
F7950		24" Rolling Tool Box	1	-
F7900		Carpet Trolley with Pneumatic Tyres	1	-
F7905		Transport & Unroll Barrow	1	-
F7956		Strong Wheeled Canvas Trolley	1	-

For prices contact your nearest distributor – see back cover

Floor Coverings

Entrance matting	84
Carpet tiles	86

Floorwise offer a carefully curated range of floor covering options to suit most applications.

Our range has been defined around a selection of colourways which offer exceptional aesthetics, durability and value for almost any commercial matting application.

Please contact us for further details and product samples.



Entrance Matting

Mat Rib

11mm



SPECIFICATION

Gel latex backed contract grade.
1m & 2m widths.

Pile weight 1600g/m²
Total weight 2620/m²
Pile composition 100% PP

Total height 11.0mm
Backing Latex

COLOURS



Anthracite Brown



Green Blue

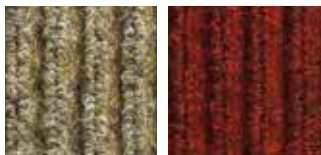

Beige Red

Mat Noppa

9.2mm

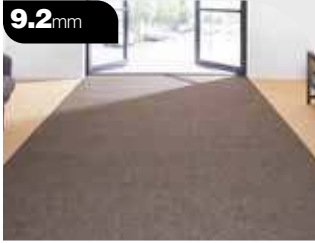

SPECIFICATION

Gel latex waffle backed contract grade.
2m width.

Pile weight 1150g/m²
Total weight 2090g/m²
Pile composition 100% PP

Total height 9.2mm
Backing Latex Waffle

COLOURS



Anthracite Brown



Green Blue



Beige Grey

Alba

7.5mm



SPECIFICATION

Heavy contract grade.
1.3m & 2m width.

Pile weight 830g/m²
Total weight 3450g/m²
Pile composition 100% NYLON
PA6

Total height 7.5mm
Backing PVC

COLOURS



Anthracite Grey 52 Brown 50



Beige 60 Sea Grey 70

Entrance Matting

Granati

8.0mm



SPECIFICATION

Contract grade matting.
1.3m & 2m width.

Pile weight 975g/m²
Total weight 3650g/m²
Pile composition 100% NYLON
PA6

Total height 8.0mm
Backing PVC

COLOURS

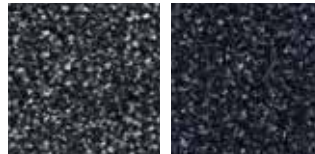

Steel Grey 72 Midnight Blue 30



Wine Red 40 Onyx Black 50

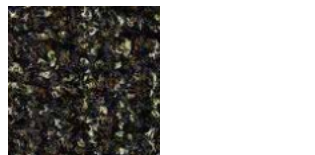

Forest Brown 60

Viking

7.8mm



SPECIFICATION

Heavy contract grade.
2m width.

Pile weight 650g/m²
Total weight 2740kg/m²
Pile composition 100% Nylon
PA6

Total height 7.8mm
Backing PVC

COLOURS



Anthracite 55 Steel Grey 75



Oak Brown 65 Dark Brown 85

Java Mat

11.5mm 13.5mm



SPECIFICATION

Contract grade synthetic coir.
1m & 2m widths.

	Flat	Rib
Pile weight	1250g/m ²	1600g/m ²
Total weight	4070g/m ²	2620g/m ²
Pile composition	100% PP	100% PP

	11.5mm	13.5mm
Total height	11.5mm	13.5mm
Backing	Crumb Rubber	Latex Waffle

COLOURS



Flat Rib

For prices contact your nearest distributor – see back cover

For prices contact your nearest distributor – see back cover

Carpet Tiles

Cubis Office

Installation

Cubis carpet tiles must be installed in accordance with the "Best Practice" techniques laid out in the Contract Flooring Association guidelines and BS5325.

Directional arrows are printed on the back of each tile. Best results are obtained when laid chequerboard. Shades may vary from batch to batch and should be checked before installation. Batches should not be mixed in the same location.

It is recommended that Floorwise F523 carpet tile tackifier is used to secure the tiles to the subfloor. Allow tackifier adhesive to completely dry before laying the tiles. The tiles can then be uplifted and relaid. Chair mats are recommended for under castor chairs.

Maintenance

Regular power vacuum cleaning is essential. Spills and surface stains can be removed by sponging with a damp cloth, or for more resistant stains, with a mild detergent solution.

TECHNICAL Specification

Manufacturing type	Tufted
Pile type	Loop pile
Gauge	1/10
Dyeing method	Solution dyed
Pile Content (ISO 2424)	100% polypropylene
Sound absorbtion	21dB
Tile backing (ISO 2424)	Bitumen with glassfibre scrim
Pile Weight (ISO 8543)	400g/m ² +/- 5%
Pile Height (ISO 1765)	2.9mm +/- 5%
Total Thickness (ISO 1765)	4.5mm +/- 5%
Total Weight (ISO 8543)	3,700g/m ² +/- 5%
Static Loading	Anti-static
Flammability (BS 4790)	Hot Metal nut test; Low radius of effect
Wear Classification	31, Moderate commercial use
Abrasion	Pass
Dimensional Stability (EN 986)	Pass
Light fastness (ISO 105 B02)	4.4
Thermal isolation	0.10m ² K/W
Wet rubbing fastness (ISO 105 X12)	15
Tile size:	Tiles 50 x 50 cm
Quantity per box	Tiles 20 (5m ²)

COLOUR



079 Charcoal



078 Greystone



072 carbon

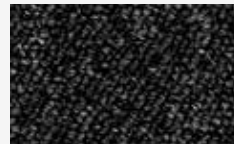

077 Shadow



073 Grey Grid



058 Blue Grid



085 Denim



084 Aegean

Carpet Tiles

Cubis Dura

Installation

Cubis carpet tiles must be installed in accordance with the "Best Practice" techniques laid out in the Contract Flooring Association guidelines and BS5325.

Directional arrows are printed on the back of each tile. The Cubis carpet tiles can be laid in various ways. Visit www.floorwise.co.uk for more information.

Shades may vary from batch to batch and should be checked before installation. Batches should not be mixed in the same location.

It is recommended that Floorwise F523 carpet tile tackifier is used to secure the tiles to the subfloor. Allow tackifier adhesive to completely dry before laying the tiles. The tiles can then be uplifted and relaid. Chair mats are recommended

Maintenance

Regular power vacuum cleaning is essential. Spills and surface stains can be removed by sponging with a damp cloth, or for more resistant stains, with a mild detergent solution.

TECHNICAL SPECIFICATION

Manufacturing type	Tufted
Pile type	Loop pile
Gauge	1/10
Dyeing method	Solution dyed
Pile Content (ISO 2424)	100% nylon
Sound absorbtion	25dB (31dB with acoustic backing)
Tile backing (ISO 2424)	Bitumen with glassfibre scrim
Pile Weight (ISO 8543)	535g/m ²
Pile Height (ISO 1765)	3.5mm
Total Thickness (ISO 1765)	5.5mm
Total Weight (ISO 8543)	3,540g/m ²
Static Loading	Anti-static
Flammability (EN 13501-1)	Bfl-s1
Wear Classification	33, Heavy commercial use
Abrasion	Pass
Dimensional Stability (EN 986)	Pass
Light fastness (ISO 105 B02)	+/-5
Castor chair test (EN 985)	A. Continuous use
Luxury / Comfort (EN 1307)	LC2
Electrostatic Charging (ISO 6536)	<2kV
Colour fastness to water	+/-4
Colour fastness to wearability	+/-4
Tile size:	Tiles 50 x 50cm / Planks 100 x 25cm
Quantity per box	Tiles 20 (5m ²) / Planks 10 (2.5m ²)



061 Pewter



062 Sapphire



080 Jet



082 Grey Coal



081 Mid Grey



083 Lagoon

Tapes

Heatseam tape	89
Adhesive tape	89
Other tape	89

Floorwise supply the flooring professional with a versatile range of tapes which won't let you down on the job.

From the plasticiser migration resistant double-sided vinyl tape to the low temperature heat seaming carpet tape, Floorwise will meet all your requirements.

Floorwise won't let you down when it comes to product quality, availability or supply.



Tapes

Product Type	Code	Product	Roll Size	Quantity
			W (mm) x L (m)	Per box
Heatseam Tape	F301	Supreme	90mm x 25m	8
	F331	Supreme Low Temperature	90mm x 25m	8
	F332	Super LT	90mm x 25m	2
	F351	Standard	90mm x 20m	8
	F391	Supreme Gold Heatseam Tape	90mm x 20m	10
Adhesive Tape	F365	Extra Heavy Duty Cloth D.S.T	50mm x 50m	24
	F366	PMR heavy duty cloth tape	50mm x 50m	24
	F366FF	Contact Tape Extra HD PMR	50mm x 50m	24
	F367	Supreme heavy duty cloth tape	50mm x 50m	24
	F368	Waterproof single sided cloth tape	50mm x 50m	24
	F374	DS PMR Vinyl Tape	50mm x 20m	36
	F377/25	Supertac contact tape	25mm x 50m	24
	F377/50	Supertac contact tape	50mm x 50m	12
	F377/85	Supertac contact tape	85mm x 50m	8



For prices contact your nearest distributor – see back cover



Artificial Grass

Artificial grass 91

Accessories 91

The all new Floorwise artificial grass range is softer and denser offering not just better value, but a better product

The Floorwise range is the Gold Star standard when it comes to comfort, luxury and durability. Transform your garden, patio, terrace or holiday home with our stunning range. Enjoy the benefits of a beautiful looking lawn with no more weeding and mowing, and welcome in your Floorwise Artificial Grass, perfect for all environments, providing a luxurious feel underfoot.

Our 6 different types present the opportunity to select from 20mm, 25mm, 30mm, 35mm, 38mm and 40mm thickness.

Each offering a natural look to bring your outdoor area to life, all year round. Ordering could not be simpler - place your order with your retail unit and have it delivered to your door.

Products come in either 2m or 4m widths, and can be cut to the full or half lineal metre.



10-Year Guarantee

Key Benefits

- Easy to install
- Low maintenance
- No watering
- Child friendly
- Pet friendly
- No more mud
- High UV stabilisation
- Cut to size/easily shaped
- 10-Year Guarantee

Range of uses

- Gardens - front and back
- Patios
- Swimming pool surrounding areas
- Play areas
- Pet soiling areas
- Holiday homes



Artificial Grass and Accessories

Product	Suitability	Pile	Colour	Length	Guarantee
		Height	Tone		
Peaks	Gardens Balconies Play areas Indoor areas Pet soiling areas	20mm	3	2m	7
				4m	7
Exmoor	Gardens Balconies Pool surrounds Play areas Pet soiling areas	25mm	3	2m	10
				4m	10
Brecon	Gardens Patios Balconies BBQ areas	30mm	3	2m	10
				4m	10
Northumberland	Gardens Balconies Patios Landscaping	35mm	3	2m	10
				4m	10
Snowdonia	Gardens Balconies Patios Landscaping	38mm	3	2m	10
				4m	10
Trossachs	Gardens Balconies Patios Landscaping	40mm	3	2m	10
				4m	10

Product	Ref	Certified	Quantity
U Shape Pins	00	BS 4790 BS 7044 EN 117	10
Aqua bond adhesive	00	BS 4790 BS 7044 EN 117	10
Weed Barrier	00	BS 4790 BS 7044 EN 117	10
Joining tape	00	BS 4790 BS 7044 EN 117	10

